



INSTALLATION GUIDE

REAR PLATFORM GEAR CAGE

UN1120B



TOOLS REQUIRED (NOT INCLUDED)

- | | |
|------------------|--------------------------|
| + RATCHET | + 9/16" SOCKET |
| + MEASURING TAPE | + 9/16" WRENCH |
| + MARKER | + 7/16" WRENCH OR SOCKET |

INSTALL INFO

TIME TO INSTALL THIS PRODUCT: 1 HOUR

Additional help is suggested for a few of the install steps.
Compatible with all FVC Rear Door Platforms.

BEFORE YOU START

Please inspect the product and packaging upon delivery to ensure there are no issues and that all parts and hardware are accounted for.

Contact us ASAP if anything is missing at:

support@flatlinevanco.com

BEFORE YOU START

All Flatline Van Co products must be properly assembled and secured before attaching to your vehicle. Improper attachment could result in an automobile accident, and could cause serious bodily injury or death to you or to others involved. You are responsible for assembling and securing Flatline Van Co products to your vehicle, checking the mounting points and attachments prior to use, and regularly inspecting the products for wear and or damage. We always recommend you use a professional to install any aftermarket accessories to your vehicle. If you have no mechanical experience and are not thoroughly familiar with the installation procedures, you must have the product installed by a professional installer or other qualified persons. The responsibility is yours and must be taken seriously for everyone's safety.



PACKAGE CONTENTS

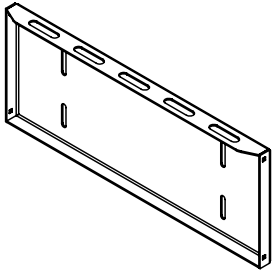

BACK PANEL

QTY: 1

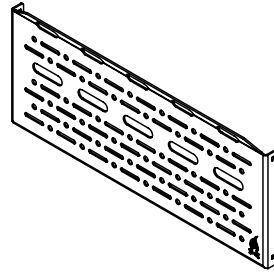

FRONT PANEL

QTY: 1

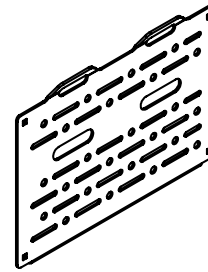

SIDE PANEL

QTY: 2

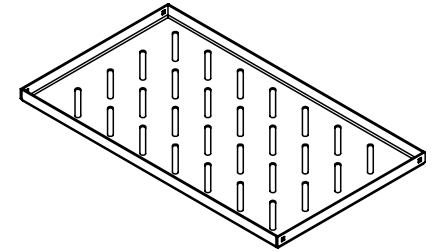

BOTTOM PAN

QTY: 1

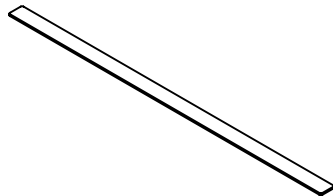

BOTTOM GASKET

QTY: 2

HARDWARE

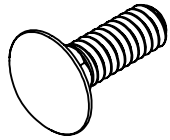

1/4-20 X 0.75 SQUARE NECK
CARRIAGE BOLT

QTY: 4

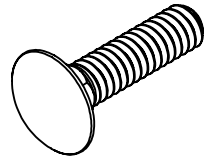

1/4-20 X 1 SQUARE NECK
CARRIAGE BOLT

QTY: 4

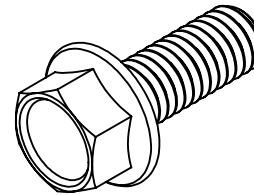

3/8-16 X 1 FLANGED HEX
HEAD SCREW

QTY: 4

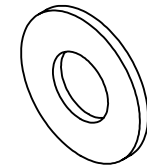

3/8 SCREW FLAT WASHER

QTY: 4

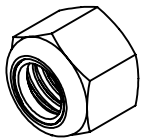

3/8 NYLON INSERT
LOCKNUT

QTY: 4

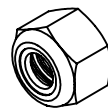

1/4-20 NYLON INSERT
LOCKNUT

QTY: 8



1/4 SCREW FLAT WASHER

QTY: 8

INSTALL

STEP | 01 LAYOUT AND INSTALL PREP

The **Rear Platform Gear Cage** is designed to be compatible with **FVC Rear Door Platforms**, but can be modified for installation with other rear door accessory systems.

1.1 Determine Mounting Height: Dry fit the cage to your mounting surface and determine the desired height of install. If you'd rather measure, see **FIG 2** for distances between the mounting points.

1.2 Modify Gear Cage (Optional): If you are using a product other than the FVC Rear Door Platform, mark the back of the **Rear Panel** to match your available mounting points and drill out (4) 3/8" holes accordingly.

PRO-TIP: A table or stand of an appropriate height can be very helpful during this install.

PRO-TIP: Masking tape can also be used to mark desired install height.

NOTE - Modifying your **Rear Storage Box Gear Cage** for mounting to products other than FVC Rear Door Platforms is done **at your own risk**. If you don't feel comfortable installing this on your own, see our **Find a Builder or Upfitter** page to locate an approved installer near you.

TOOLS REQUIRED FOR THIS STEP: + MEASURING TAPE
+ MARKER

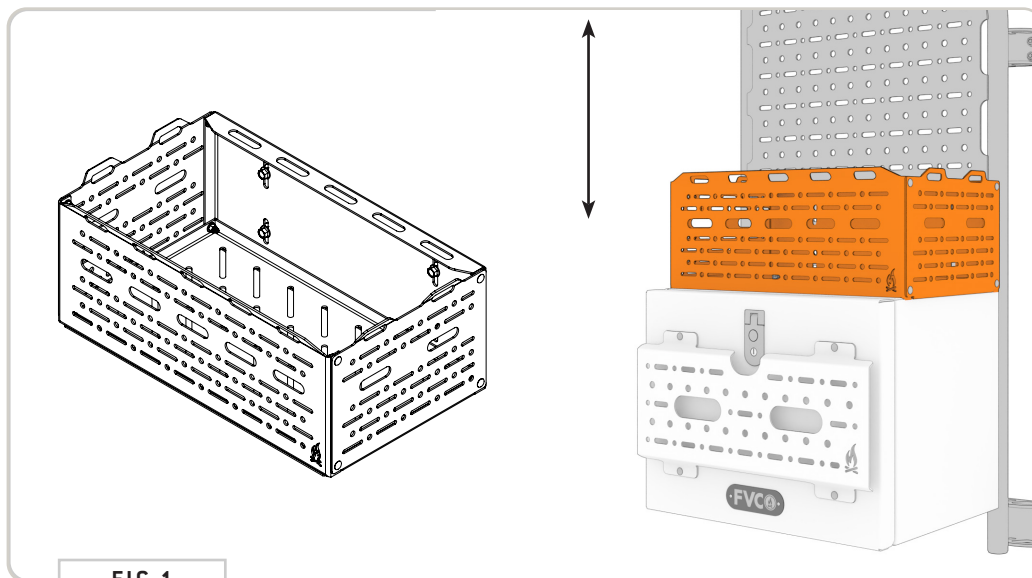

FIG 1

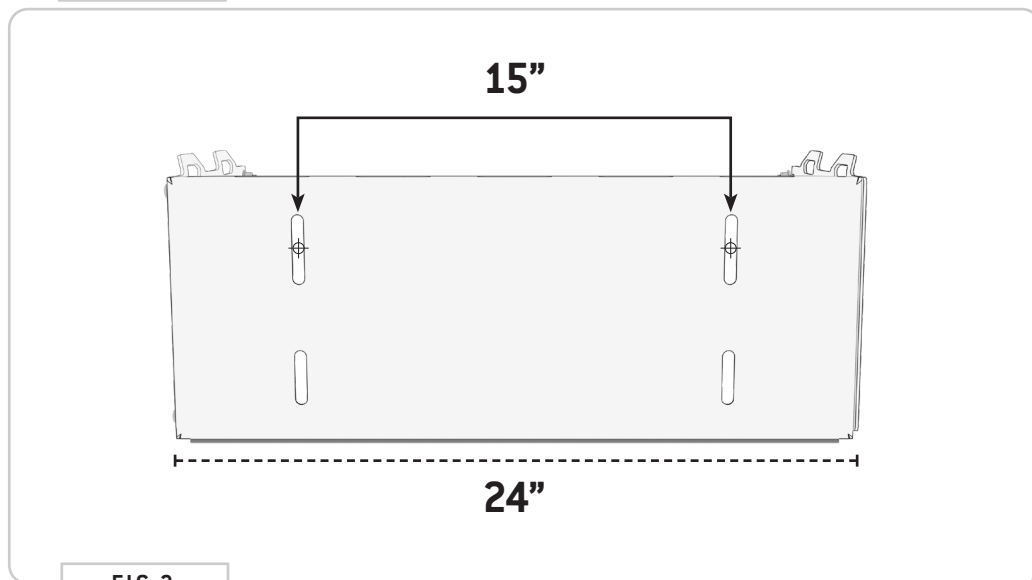

FIG 2

TOOLS REQUIRED FOR THIS STEP:

STEP | 02 GEAR CAGE ASSEMBLY

2.1 Position Back Panel to Bottom Pan: Position the **Back Panel** to the **Bottom Pan** in the orientation as shown in **FIG 3** and **4**.

2.2 Position Front Panel to Bottom Pan: Position the **Front Panel** to the **Bottom Pan** in the orientation shown in **FIG 5+6**.



FIG 3



FIG 4

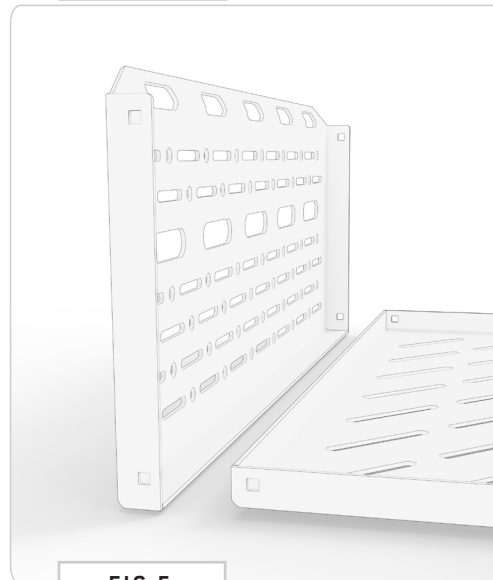

FIG 5



FIG 6

STEP | 02 GEAR CAGE ASSEMBLY

2.3 Position Side Panels: Position the (2) Side Panels in the orientation as shown in FIG 7+8.

TOOLS REQUIRED FOR THIS STEP:

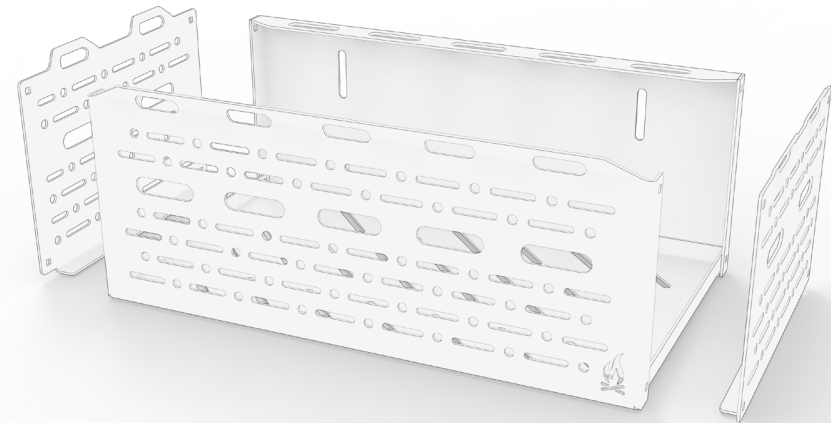

FIG 7

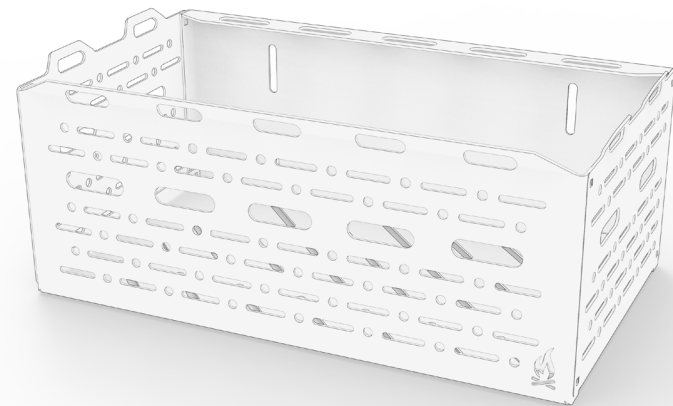

FIG 8

TOOLS REQUIRED FOR THIS STEP: + 7/16" WRENCH OR SOCKET

STEP | 02 GEAR CAGE ASSEMBLY

2.4 Secure Panels to Bottom Pan: Secure the panels to the Bottom Pan using the supplied 1/4-20 x1 Carriage Bolts, Flat Washers and Nylon Locknuts (FIG 9+10).

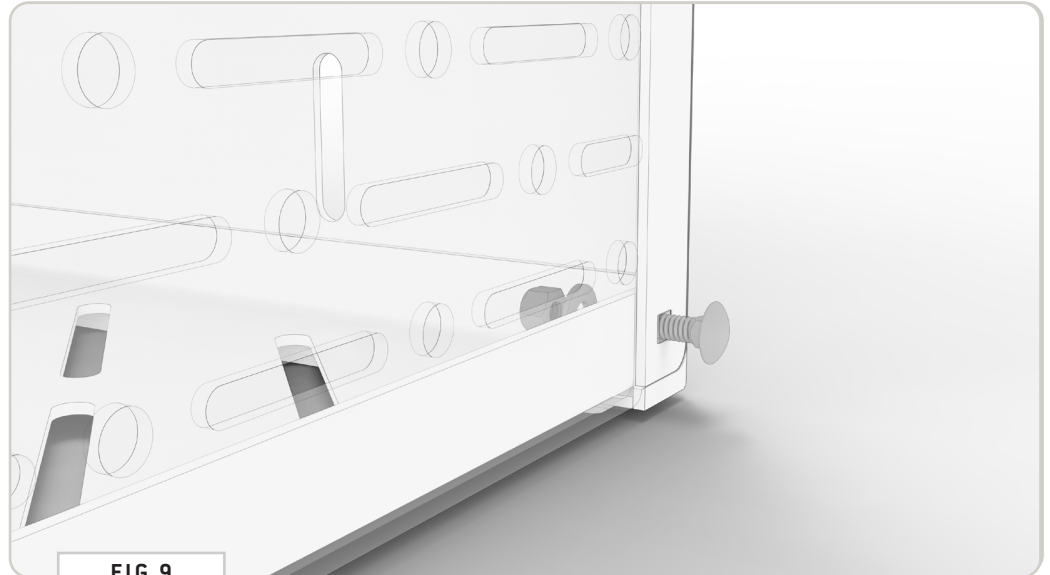

FIG 9



FIG 10

TOOLS REQUIRED FOR THIS STEP: + 7/16" WRENCH OR SOCKET

STEP | 02 GEAR CAGE ASSEMBLY

2.5 Secure Panels: Secure the assembly using the supplied 1/4-20 x0.75 Carriage Bolts, Flat Washers and Nylon Locknuts (FIG 11+12).

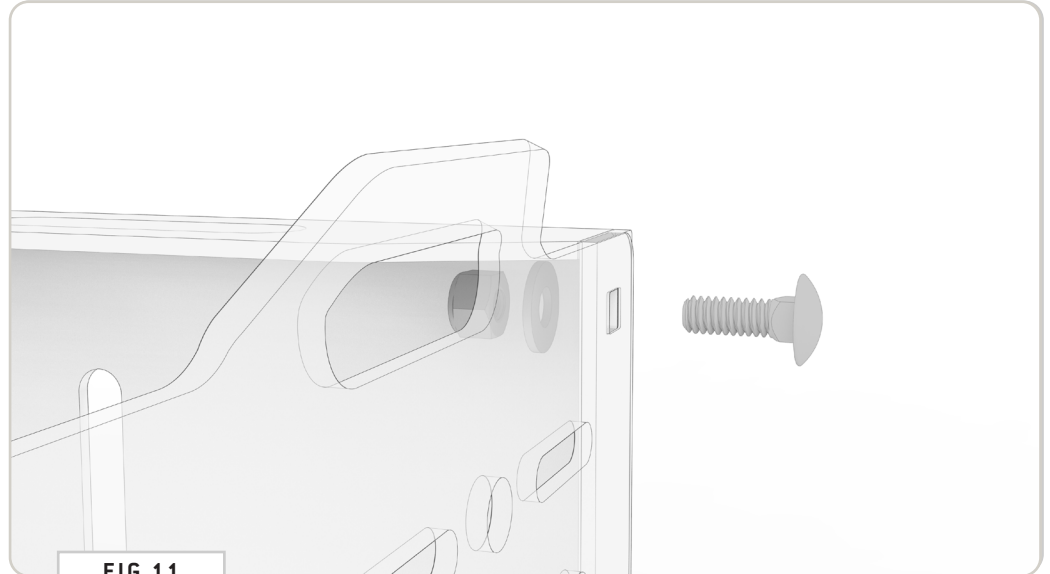

FIG 11

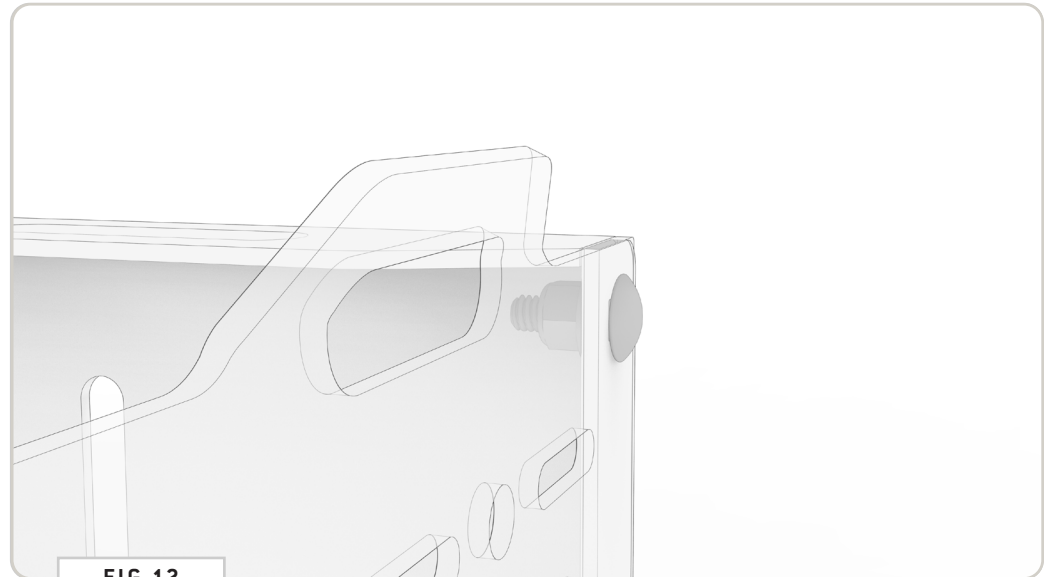

FIG 12

STEP | 02 GEAR CAGE ASSEMBLY

2.6 Adhere Gaskets to Gear Cage (Optional): The **Gear Cage Front and Rear Panels** may or may not have foam gaskets pre-installed. If you are installing this in conjunction with a **Storage Box** or other **Rear Door Accessory**, you may elect to attach the included **Foam Gaskets** to the bottom to avoid rubbing.

TOOLS REQUIRED FOR THIS STEP:

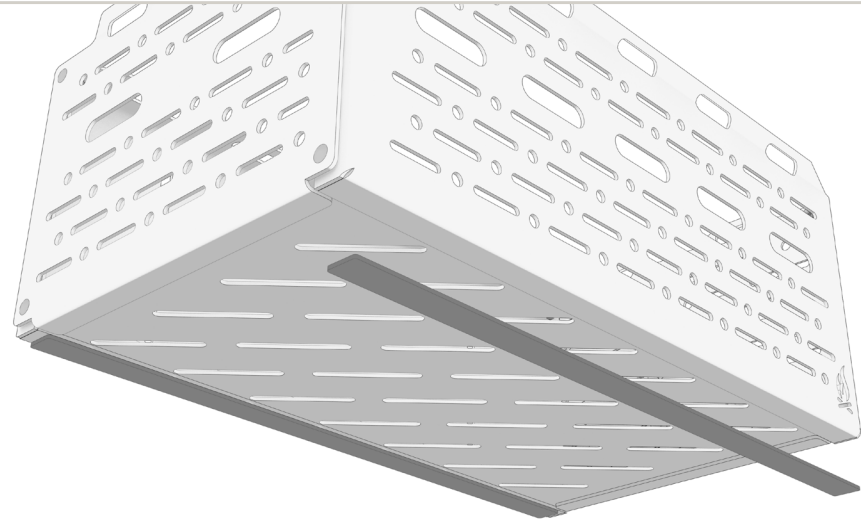

FIG 13

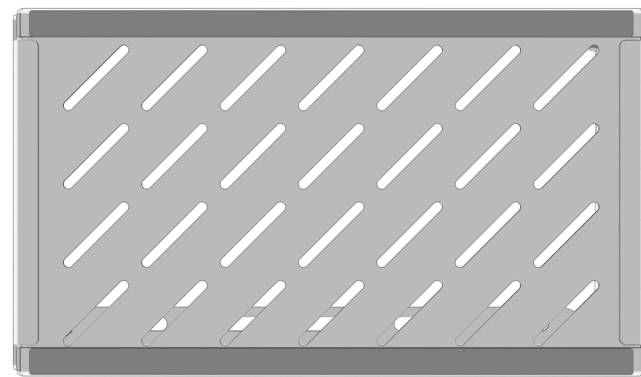

FIG 14

STEP | 03 GEAR CAGE INSTALL

3.1 Insert Bolts to Upper Mounting Holes: Insert (1ea) 3 / 8-16 x 1" Flanged Hex Head Screws and 3 / 8" Flat Washers to the upper mounting holes.

3.2 Position Gear Cage to Platform: With help, lift and align top holes with hardware to the desired height of horizontal 3/8" sized slots of the **Rear Door Platform**.

3.3 Loosely Secure Gear Cage to Platform: Reaching around the platform, attach (1ea) 3 / 8" Flat Washers to the bolts and loosely thread on (1ea) 3 / 8" Nylon Lock Nuts.

3.4 Confirm Install Height and Secure Fasteners: Once the **Gear Cage** is in position, secure the upper fasteners to hold it in place.

3.5 Lower Mounting Holes: Insert (1ea) 3 / 8-16 x 1" Flanged Hex Head Screws and 3 / 8" Flat Washers to the lower mounting holes.

3.6 Secure Lower Mounting Holes: Reaching around the platform, attach (1ea) 3 / 8" Flat Washers to the bolt and thread on (1ea) 3 / 8" Nylon Lock Nuts.

3.7 Tighten All Fasteners: Verify positioning and tighten down hardware to **20 ft-lbs**

TOOLS REQUIRED FOR THIS STEP: + RATCHET
+ 9/16" SOCKET
+ 9/16" WRENCH

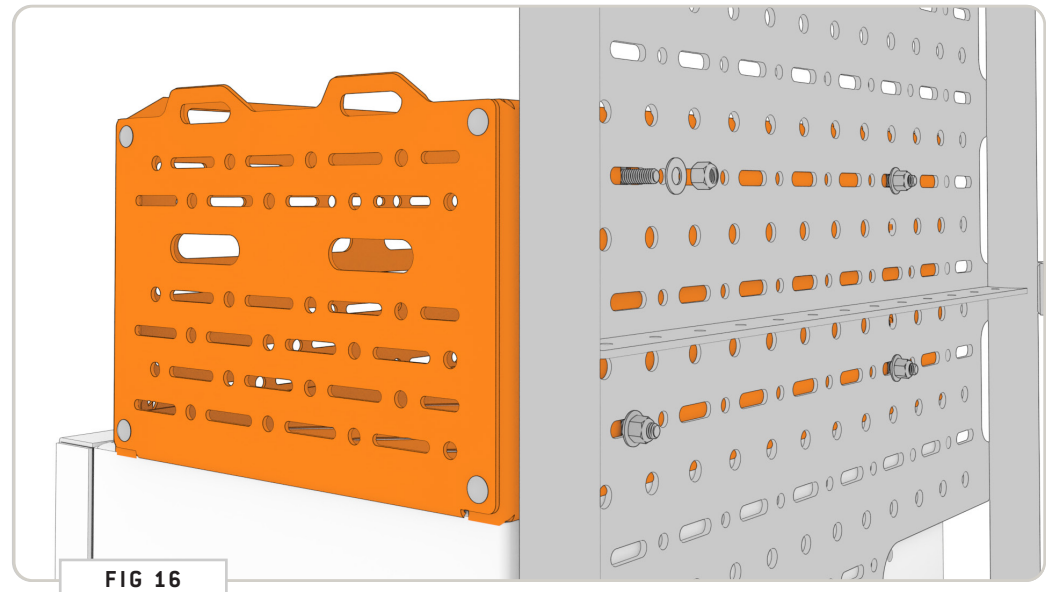
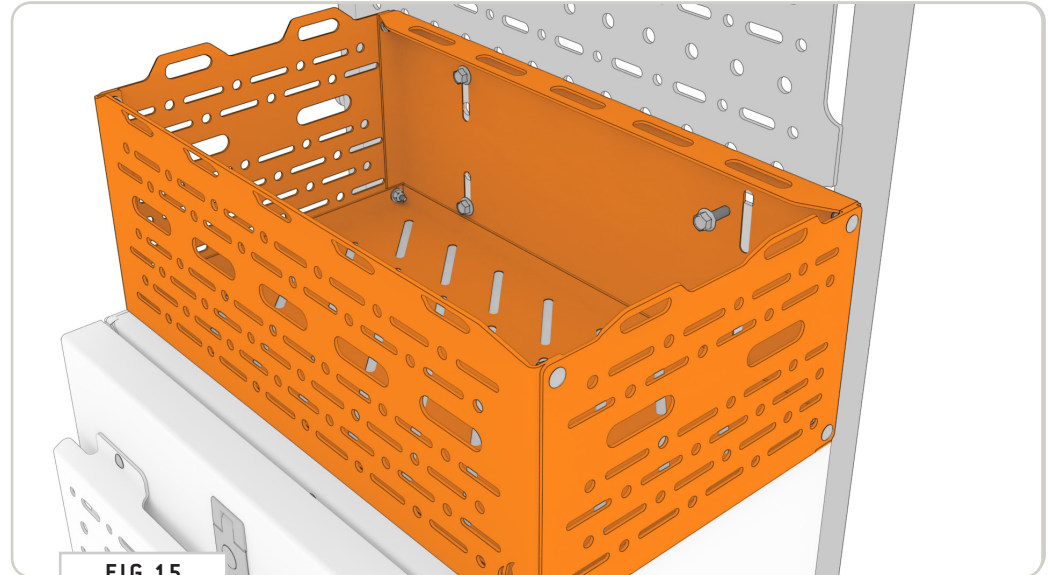

GET OUT AND EXPLORE!

+ LEAVE US A REVIEW

Happy with your new FVC product? We would love to hear (and see) from you! Head to the product page and click "Leave Review." Add a short review and upload a few photos to be showcased on the product page.

+ SHARE YOUR PICS

We love seeing how our customers use their FVC products and following along with your adventures. Tag us in your photos with: @flatlinevanco or send them to us via email. We love posting customer pictures in our feed!

+ NEED ANY HELP?

If you are having any issues with your product, please reach out, and we will make it right. FVC is a company of van and outdoor enthusiasts that design and use our own products, so we want you to be as stoked on your new parts as we are!



@FLATLINEVANCO