



INSTALLATION GUIDE

TRANSIT VAN LOW PRO ROOF RACK - 130" MID ROOF

TR0108B



TOOLS REQUIRED (NOT INCLUDED)

- | | |
|-------------------------|----------------------|
| + CHISEL | + 5/32" ALLEN WRENCH |
| + DIE GRINDER | + 3/16" ALLEN WRENCH |
| + RATCHET | + 7/16" SOCKET |
| + 7/16" BOX WRENCH | + EXTERIOR SEALANT |
| + 13MM WRENCH OR SOCKET | + CAULKING GUN |

INSTALL INFO

TIME TO INSTALL THIS PRODUCT: 1-2 HOURS

Additional help is suggested for a few of the install steps.

BEFORE YOU START

Please inspect the product and packaging upon delivery to ensure there are no issues and that all parts and hardware are accounted for.

Contact us ASAP if anything is missing at:
support@flatlinevanco.com

BEFORE YOU START

All Flatline Van Co products must be properly assembled and secured before attaching to your vehicle. Improper attachment could result in an automobile accident, and could cause serious bodily injury or death to you or to others involved. You are responsible for assembling and securing Flatline Van Co products to your vehicle, checking the mounting points and attachments prior to use, and regularly inspecting the products for wear and or damage. We always recommend you use a professional to install any aftermarket accessories to your vehicle. If you have no mechanical experience and are not thoroughly familiar with the installation procedures, you must have the product installed by a professional installer or other qualified persons. The responsibility is yours and must be taken seriously for everyone's safety.



PACKAGE CONTENTS

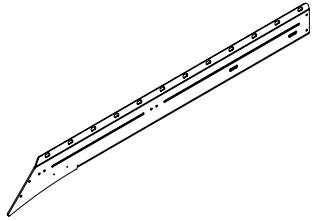

FRONT DRIVER RAIL

QTY: 1

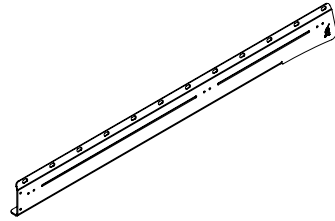

REAR DRIVER RAIL

QTY: 1

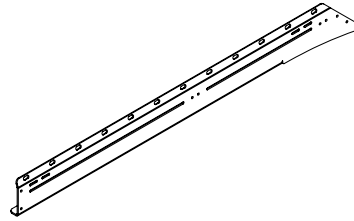

FRONT PASSENGER RAIL

QTY: 1

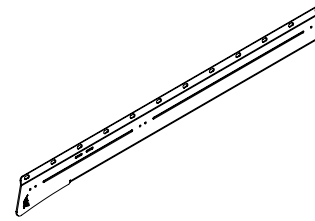

REAR PASSENGER RAIL

QTY: 1

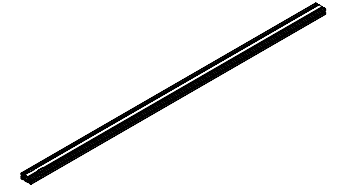

CROSSBARS

QTY: 6

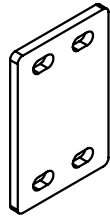

RAIL CONNECTING PLATES

QTY: 2

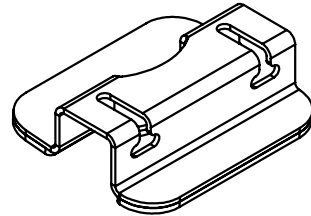

LANDING PADS

QTY: 6

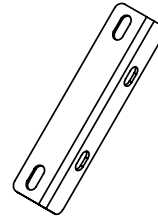

FAIRING BRACKET 1

QTY: 1

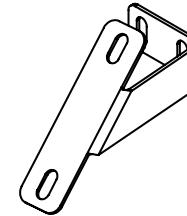

FAIRING BRACKET 2

QTY: 1

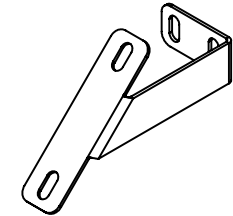

FAIRING BRACKET 3

QTY: 1

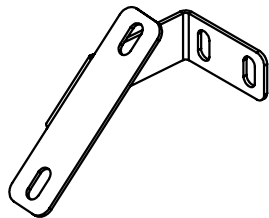

FAIRING BRACKET 4

QTY: 1

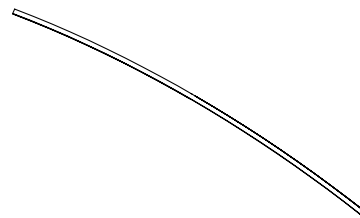

FAIRING GASKET

QTY: 1

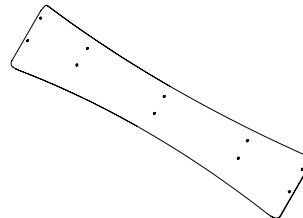

FRONT FAIRING

QTY: 1

HARDWARE

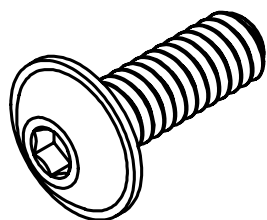

1/4-20 X 0.75 FLANGED
BUTTON HEAD HEX
DRIVE SCREW

QTY: 46

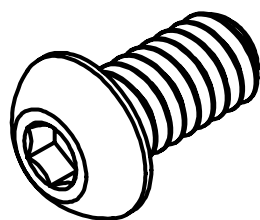

1/4-20 X 0.5 BUTTON
HEAD HEX DRIVE
SCREW

QTY: 6

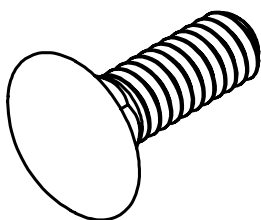

1/4-20 X 0.75
SQUARE NECK
CARRIAGE BOLT

QTY: 12

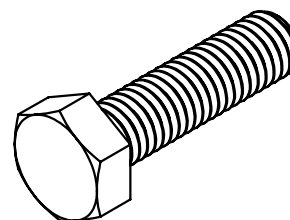

M8-1.25 X 30 HEX
HEAD SCREW

QTY: 6

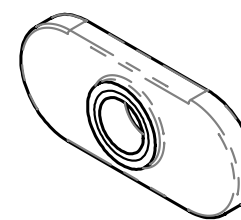

1/4-20 T-NUTS

QTY: 6

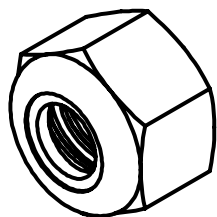

1/4-20 NYLON INSERT
LOCKNUT

QTY: 34

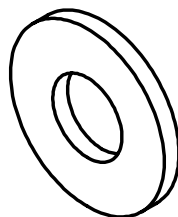

1/4" SCREW FLAT
WASHER

QTY: 40

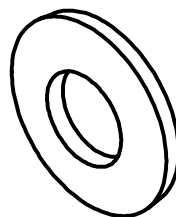

1/4" SCREW BELLEVILLE
SPRING LOCK WASHER

QTY: 6

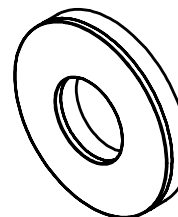

5/16" SCREW BONDED
SEALING WASHER

QTY: 6

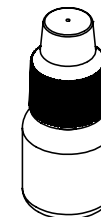

THREADLOCKER

QTY: 1

INSTALL

STEP | 01 LAYOUT AND INSTALL PREP

1.1 Remove Mounting Hole Caps: Use a heat gun on a low temperature setting to loosen up the adhesive that holds the mounting hole caps to the top of the van. There should be six total. Use a chisel or plastic pry tool to gently remove them from the mounting surface (FIG 1).

1.2 Clean Mounting Surface: Clean the area using goo-gone and denatured alcohol to thoroughly remove any adhesive residue (FIG 2).

1.3 Ensure Bolt Clearance: Dry fit the landing pads onto the mounting surface and ensure that bolts can pass through to the factory threaded slots (FIG 3). If there are clearance issues, use a die grinder to carefully enlarge the holes for access to threaded mounting holes (FIG 4).

TOOLS REQUIRED FOR THIS STEP: + CHISEL
+ DIE GRINDER OR METAL FILE

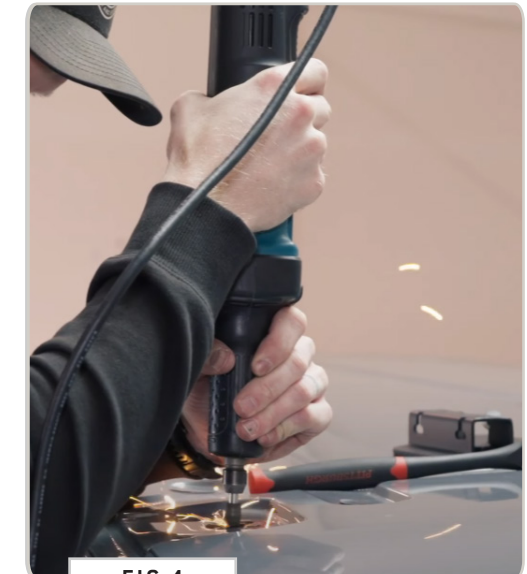

TOOLS REQUIRED FOR THIS STEP: + 13MM BOX WRENCH OR SOCKET
+ CAULKING GUN

STEP | 02 LANDING PAD INSTALL

2.1 Install Landing Pads: Secure the landing pads to the roof by tightening down M8 Bolts with loctite and 5/16" Bonded Sealing Washers (FIG 5+6).

2.2 Apply Sealant: Apply a small bead of exterior waterproof sealant around the outside of each landing pad (FIG 7).



FIG 5

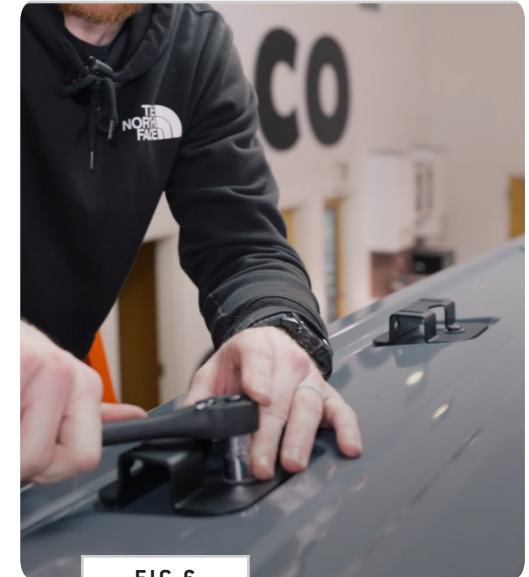

FIG 6



FIG 7

TOOLS REQUIRED FOR THIS STEP: + 7/16" WRENCH OR SOCKET
+ 3/16" ALLEN WRENCH

STEP | 03 SIDE RAIL INSTALL

3.1 Install Side Rails: Place the **Side Rails** onto the **Landing Pads** and loosely secure them with **1/4"-20 Carriage Bolts, Flat Washers and Nylock Locknuts** (FIG 8+9).

3.2 Secure Rails With Connecting Plates: Utilize **Rail Connecting Plates** to connect the front and rear rails together using **1/4"-20 Flanged Head Screws, Flat Washers and Nylock Locknuts** (FIG 10+11).

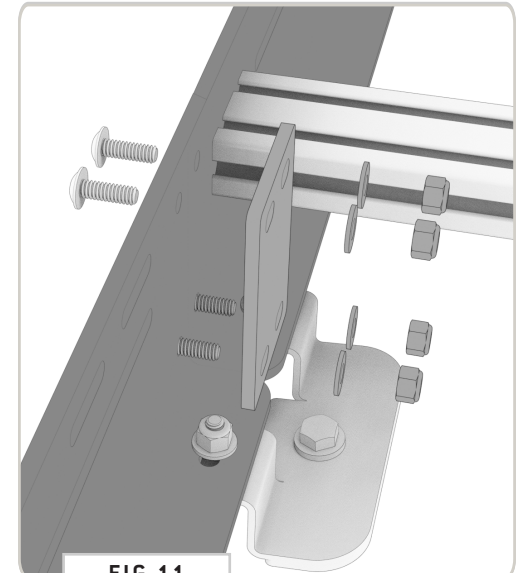
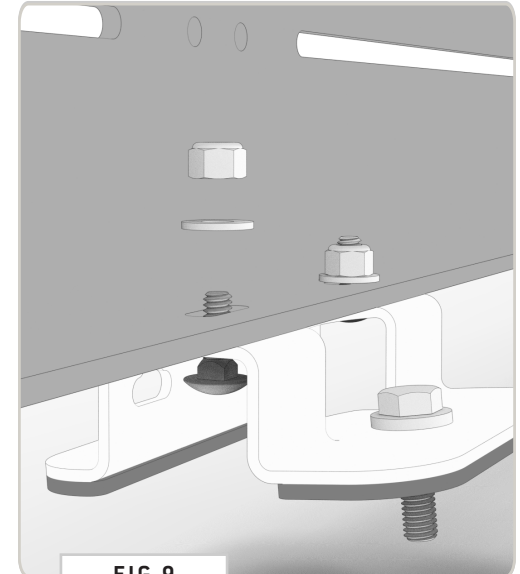

TOOLS REQUIRED FOR THIS STEP: + 3/16" ALLEN WRENCH

CROSSBAR INSTALL

4.1 Layout Crossbar Locations: Position the crossbars in your desired locations, loosely threading in the **1/4-20 Flange Head Screws** to hold in place (FIG 12+13).

NOTE - Leave one crossbar aside for mounting the fairing in the next step.

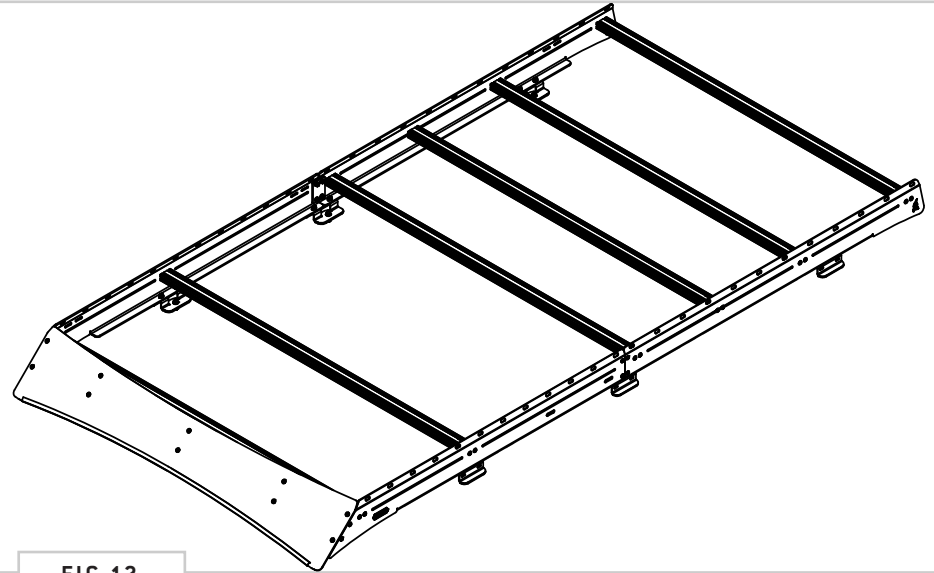

FIG 12



FIG 13

TOOLS REQUIRED FOR THIS STEP: + 5/32" ALLEN WRENCH

STEP | 05 FAIRING ASSEMBLY

5.1 Fairing Assembly: Loosely assemble the fairing brackets with (2ea) 1/4-20" Button Head Screws, Lock Washers and T-Nuts as shown in FIG 14. Slide the assemblies into the cross-bar (FIG 15) along the locations shown in FIG 16.



FIG 14



FIG 15

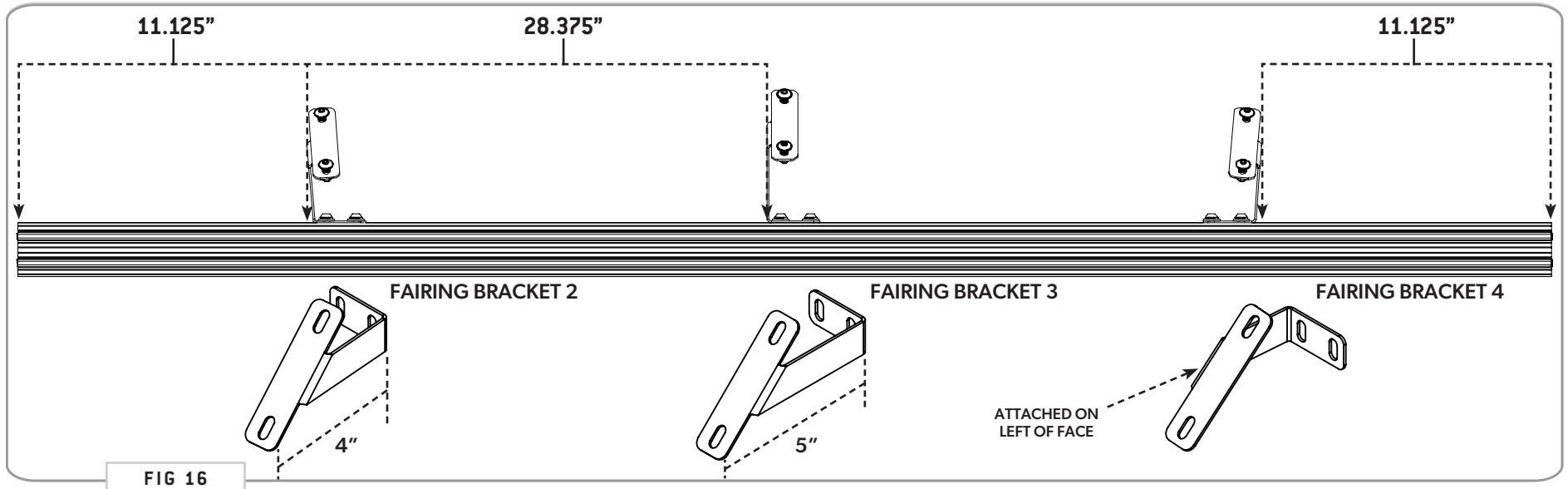

FIG 16

TOOLS REQUIRED FOR THIS STEP: + 5/32" ALLEN WRENCH
+ 7/16" WRENCH OR SOCKET

STEP | 05 FAIRING ASSEMBLY

5.2 Secure Fairing Brackets to Crossbar: Align holes in face of **Fairing** to those of the **Fairing Brackets** to confirm correct fitment and secure to **Crossbar** by tightening down the **1/4"-20" Button Head Screws** (FIG 17).

5.3 Attach Fairing: Loosely attach the **Fairing** to the **Fairing Brackets** using **1/4"-20 Flanged Head Screws, Flat Washers and Nylock Locknuts** (FIG 18).

5.4 Attach Fairing Brackets 1 and 5: Loosely attach **Fairing Brackets 1 and 5** to the **Fairing Assembly** using **1/4"-20 Flanged Head Screws, Flat Washers and Nylock Locknuts**. Note that the flanged face of these Fairing Brackets will face outward as shown in FIG 19.

5.5 Attach Trim Gasket: Complete the assembly by attaching the **Trim Gasket** (FIG 20). Make sure that the "bulbed" side of the trim is facing the Crossbar, as that will be the part that sits against the van.

PRO-TIP: Gently tap the **Trim Gasket** using a mallet to seat it down tight against the **Fairing**.



FIG 17

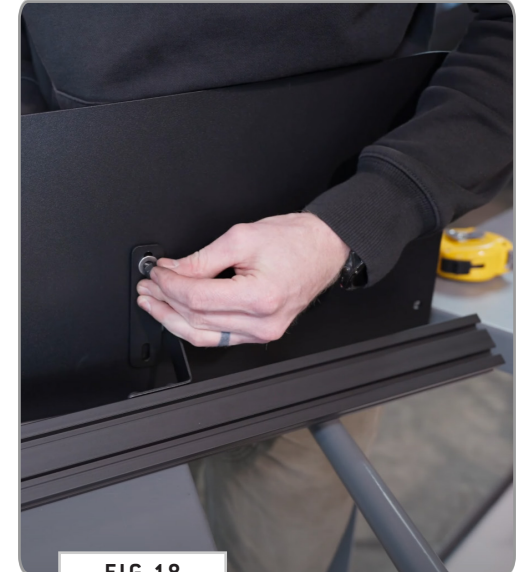

FIG 18



FIG 19

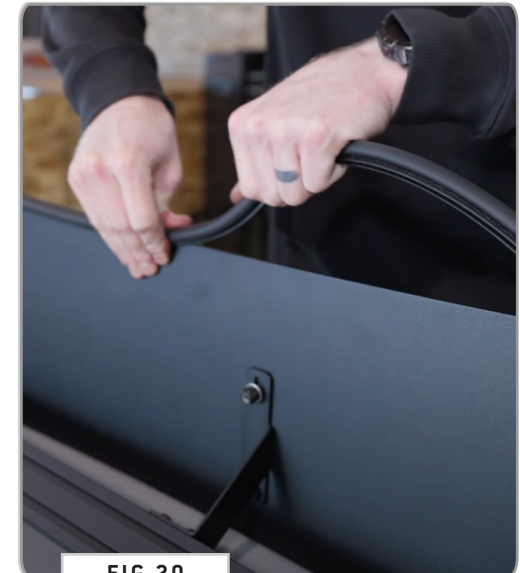

FIG 20

TOOLS REQUIRED FOR THIS STEP: + 5/32" ALLEN WRENCH
+ 7/16" WRENCH OR SOCKET

STEP | 06 FAIRING INSTALL

6.1 Install Fairing: With help, lift the **Fairing Assembly** up to the front of your **Roof Rack** and gently lay it down on a soft surface (**FIG 21**).

6.2 Tighten Fairing to Brackets: There is a bit of adjustment built in to the **Fairing Brackets** so that you maintain a tight seal against the van body during install. Proceed to tighten down the fasteners holding the **Fairing** to the **Fairing Brackets** once you've determined an appropriate fit (**FIG 22**).

6.3 Tighten Fairing to Side Rails: Tighten down the fasteners holding the **Fairing Assembly** to the **Side Rails** (**FIG 23**).



FIG 21



FIG 22



FIG 23

STEP | 07 ADJUSTMENTS AND TUNING

7.1 Secure Crossbars: Begin tightening the **Crossbars** into place, starting with the front-most crossbar.

7.2 Left-To-Right Adjustment: Check to make sure you are happy with your alignment to the van Left-To-Right (**FIG 24**). If you are running an awning, or have other accessories to account for, you can adjust the placement of the rack at this time.

7.3 Front-To-Back Adjustment: Check to make sure you are happy with your alignment to the van Front-To-Back. Once you are happy with how the rack is aligned, proceed to tighten down fasteners holding the **Side Rails** to the **Landing Pads** (**FIG 25**).

TOOLS REQUIRED FOR THIS STEP: + 3/16" ALLEN WRENCH
+ 7/16" WRENCH OR SOCKET



FIG 24



FIG 25

GET OUT AND EXPLORE!

+ LEAVE US A REVIEW

Happy with your new FVC product? We would love to hear (and see) from you! Head to the product page and click “Leave Review.” Add a short review and upload a few photos to be showcased on the product page.

+ SHARE YOUR PICS

We love seeing how our customers use their FVC products and following along with your adventures. Tag us in your photos with: @flatlinevanco or send them to us via email. We love posting customer pictures in our feed!

+ NEED ANY HELP?

If you are having any issues with your product, please reach out, and we will make it right. FVC is a company of van and outdoor enthusiasts that design and use our own products, so we want you to be as stoked on your new parts as we are!



@FLATLINEVANCO