



INSTALLATION GUIDE

SPRINTER VAN SIDE STEPS - 170"

SP1119B



TOOLS REQUIRED (NOT INCLUDED)

- | | |
|--------------------|------------------|
| + IMPACT DRIVER | + RIVET NUT TOOL |
| + DRILL | + 9/16" SOCKET |
| + 3/8" DRIVER BIT | + 7/16" SOCKET |
| + 3/16" DRILL BIT | + RATCHET |
| + 17/32" DRILL BIT | + BLUE LOCTITE |
| + 7/32" ALLEN KEY | + TAPE MEASURE |
| + 5/32" ALLEN KEY | + MARKER |

INSTALL INFO

TIME TO INSTALL THIS PRODUCT: 2 HOURS

Additional help is suggested for a few of the install steps.

BEFORE YOU START

Please inspect the product and packaging upon delivery to ensure there are no issues and that all parts and hardware are accounted for.

Contact us ASAP if anything is missing at:

support@flatlinevanco.com

BEFORE YOU START

All Flatline Van Co products must be properly assembled and secured before attaching to your vehicle. Improper attachment could result in an automobile accident, and could cause serious bodily injury or death to you or to others involved. You are responsible for assembling and securing Flatline Van Co products to your vehicle, checking the mounting points and attachments prior to use, and regularly inspecting the products for wear and or damage. We always recommend you use a professional to install any aftermarket accessories to your vehicle. If you have no mechanical experience and are not thoroughly familiar with the installation procedures, you must have the product installed by a professional installer or other qualified persons. The responsibility is yours and must be taken seriously for everyone's safety.



PACKAGE CONTENTS

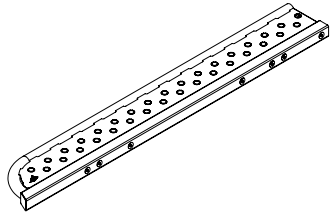

PASSENGER STEP
WELDMENT - FRONT

QTY: 1

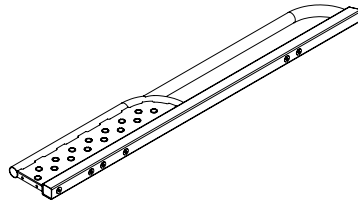

PASSENGER STEP
WELDMENT - REAR

QTY: 1

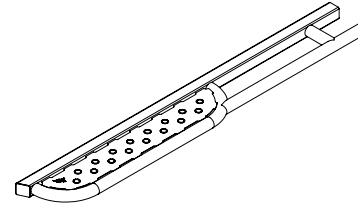

DRIVER STEP WELDMENT -
FRONT

QTY: 1

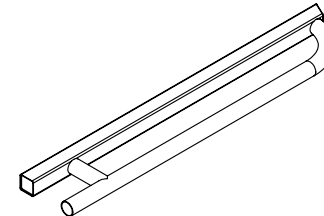

DRIVER STEP WELDMENT -
REAR

QTY: 1

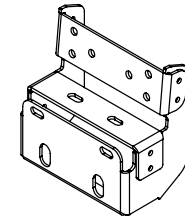

SHORT HANGAR BRACKET

QTY: 5

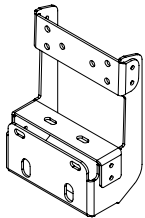

TALL HANGAR BRACKET

QTY: 3

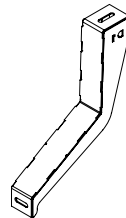

DRIVER SIDE BRACE D1

QTY: 1

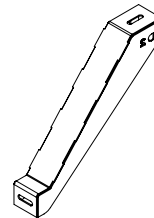

DRIVER SIDE BRACE D2

QTY: 2

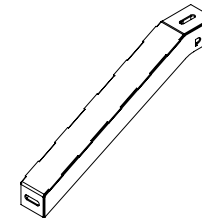

PASSENGER SIDE BRACE P1

QTY: 1

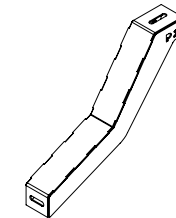

PASSENGER SIDE BRACE P2

QTY: 2

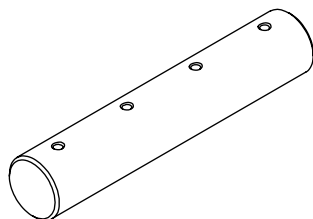

BAYONET

QTY: 2

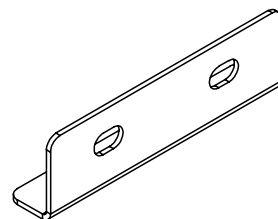

JOINING BRACKET

QTY: 2

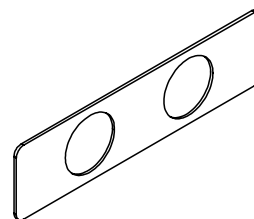

BRACKET SPACER - DOUBLE

QTY: 8

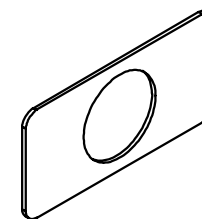

BRACKET SPACER - SINGLE

QTY: 6

HARDWARE

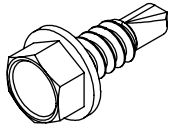

1/4-20 x 0.75 HEX HEAD
DRILLING SCREW

QTY: 80

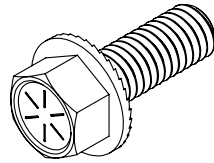

3/8 x 1 SERRATED FLANGED
HEX HEAD SCREW

QTY: 32

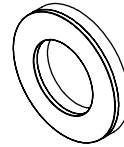

3/8 BONDED SEALING
WASHER

QTY: 14

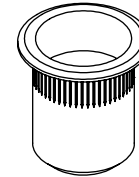

3/8-16 x 0.027-0.15 HEAVY
DUTY RIVET NUT

QTY: 6

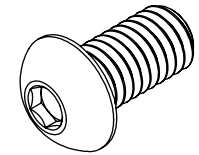

3/8-16 x 0.75 BUTTON
HEAD HEX DRIVE SCREW

QTY: 14

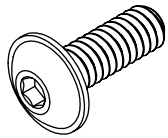

1/4-20 x 0.75 FLANGED
BUTTON HEAD HEX SCREW

QTY: 10

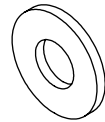

1/4 FLAT WASHER

QTY: 2

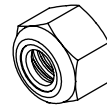

1/4 NYLON LOCKNUT

QTY: 2

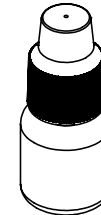

THREADLOCKER

QTY: 1

INSTALL

STEP | 01 WELDMENT ASSEMBLY

1.1 To begin your install, locate the **Front and Rear Weldments** of the side steps and lay them down carefully as shown in the first picture.

1.2 Slide a **Bayonet** into the tubing of the Front Passenger Weldment until the first two holes of the Bayonet line up with the holes of the tubing. Apply blue Loctite to two **1/4-20x0.75 Button Hex Drive Screws** and loosely thread them in to the Bayonet to hold it in place.

1.3 Slide the **Rear Passenger Weldment** onto the protruding end of the bayonet and loosely thread on two more **1/4-20 Screws** with Loctite.

1.4 Retrieve a **Joining Bracket** and place the short side along the bottom of the step directly across from the Bayonet. Line up the two holes of the bracket with the two holes of the square tubing and obtain two **3/8-16x1 Serrated Flanged Hex Head Screws**, applying Loctite before loosely threading them into place.

1.5 Check the alignment of all the joined parts and tighten the hardware down using a 5/32" Allen wrench and 9/16" Socket respectively.

1.6 Repeat this process for the Driver's Side Step Assembly.

NOTE - The **Joining Bracket** is used to help with alignment of the two weldments and can be clamped in place while tightening to ensure alignment.

TOOLS REQUIRED FOR THIS STEP:

- + 5/32" ALLEN WRENCH
- + 9/16" SOCKET
- + RATCHET
- + LOCTITE

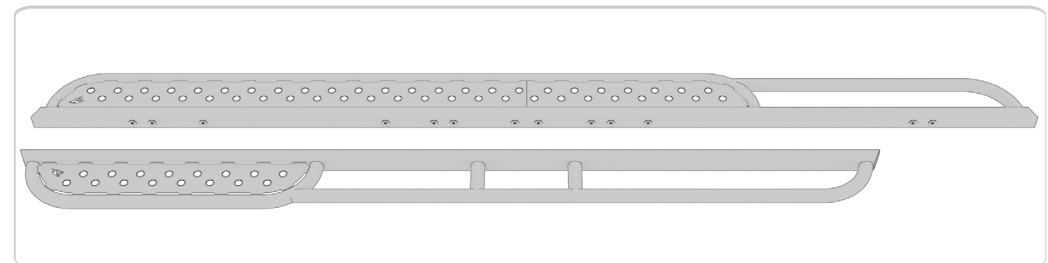
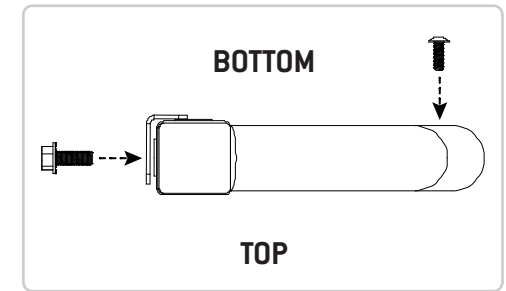
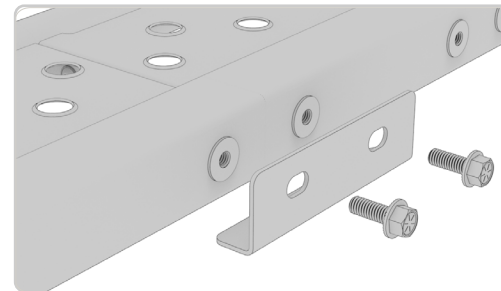
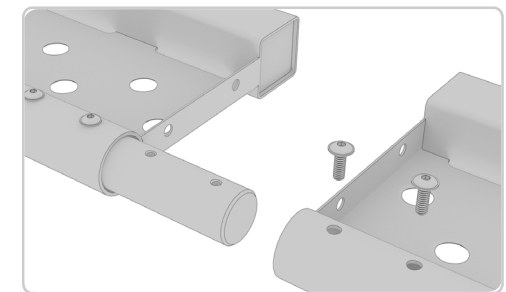
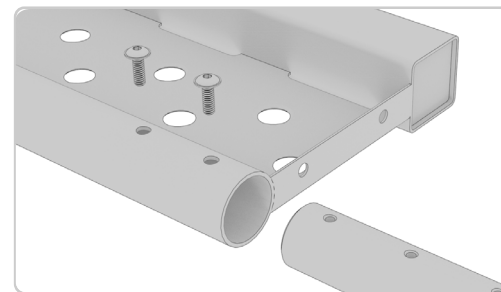
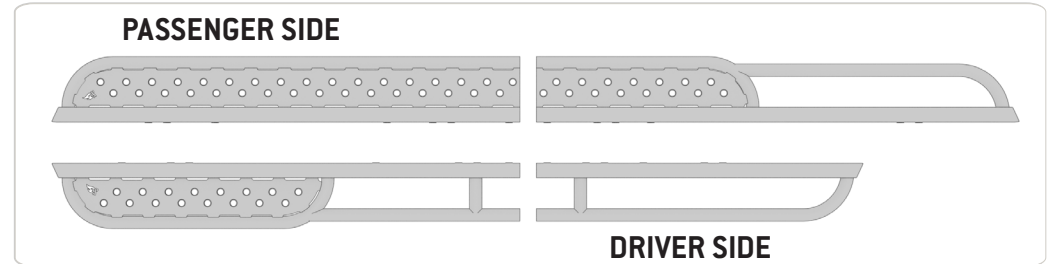

TOOLS REQUIRED FOR THIS STEP: + 7/32" ALLEN WRENCH

STEP | 02 SEALING WELDMENTS

2.1 Reveal the bottom-most set of mounting holes by turning the assembled steps upside-down. These will need to be plugged using **3/8-16x0.75 Button Head Hex Drive Screws** and **3/8 Bonded Sealing Washers** in order to protect them from the elements. The first graphic depicts the locations for the Passenger Side Weldment.

2.2 Affix a **Bonded Sealing Washer** to the screw and apply Loctite to the threads before tightening it down into the weldment with a 7/32" Allen Key. The screw should be turned to the point where the conical sealing washer flattens and the black rubber is set tight against the weldment.

2.3 Repeat this process for the Driver's Side Weldment.

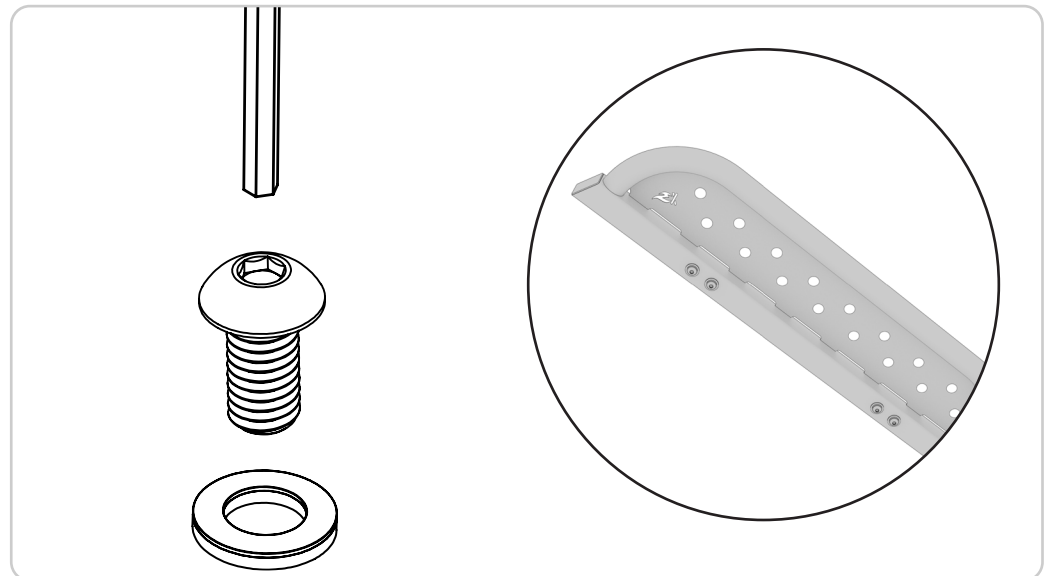
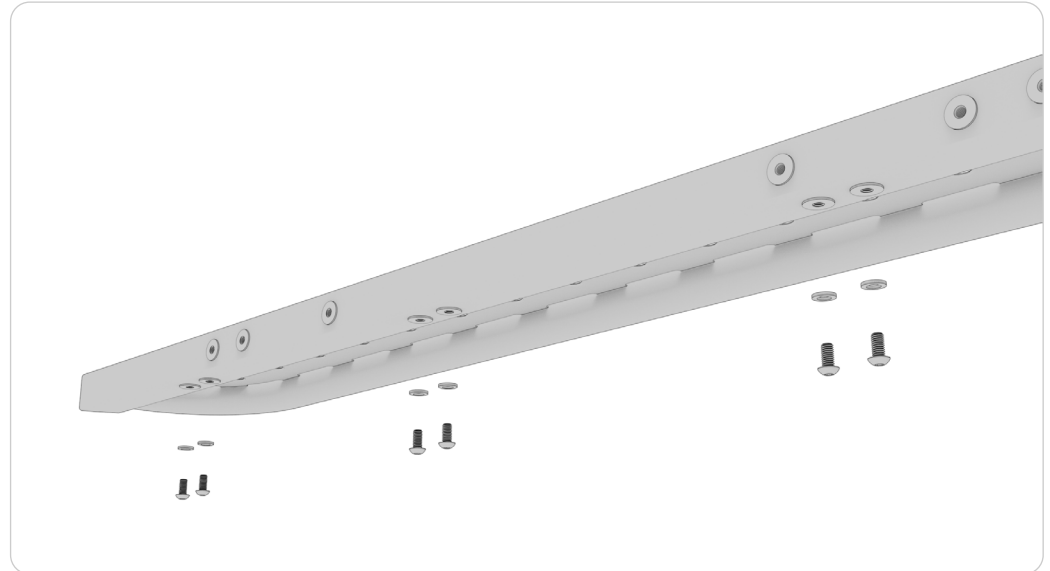

STEP | 03 HANGAR LOCATIONS

Now we will begin to measure and mark the locations of where to mount each **Hangar Bracket** along the welded pinch seam of your van body.

For 3rd generation Sprinters (VS30 chassis) [2019+]

3.1a Using the front jack point as your reference, layout the bracket locations according to the dimensions listed on the right.

For 2nd generation Sprinters (NCV3 chassis) [2007-2018]

3.1b Using the body seam as your reference, lay out the bracket locations with an inch added to each of the dimensions listed. The body seam is where the front door meets the front wheel well panel. There is an indent on the undercarriage where this seam lies.

NOTE - These are centerline dimensions. Your mark on the pinch seam will align with the centerline notch cut into the Hangar Bracket. Also note the labels next to the brackets in the diagram; the short brackets are labeled "S" and the tall brackets are labeled "T". The two tall brackets go to the rear of the van on the driver side as shown.

NOTE - Ensure that your marks are accurate. While there is a small amount of adjustment built into the bracket mount holes for tolerance, labeling your marks for each bracket type as you go is a good way to avoid placing the wrong bracket in the wrong location.

TOOLS REQUIRED FOR THIS STEP: + TAPE MEASURE
+ MARKER

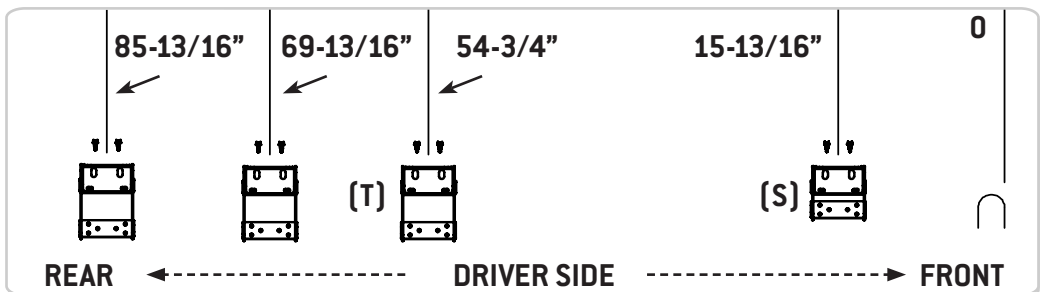
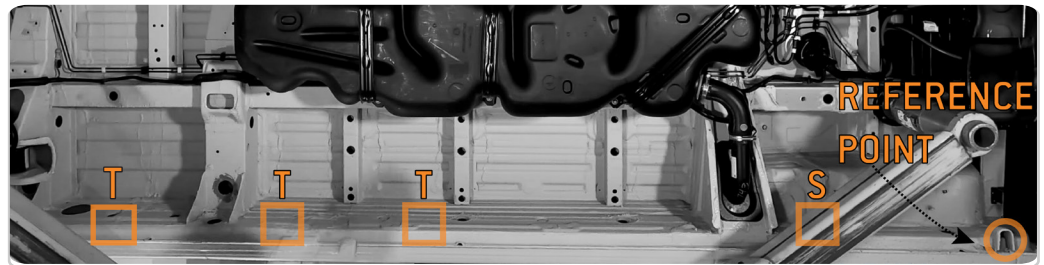
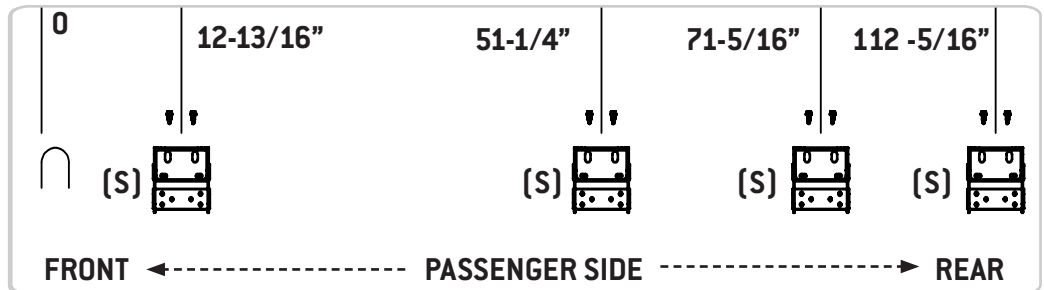
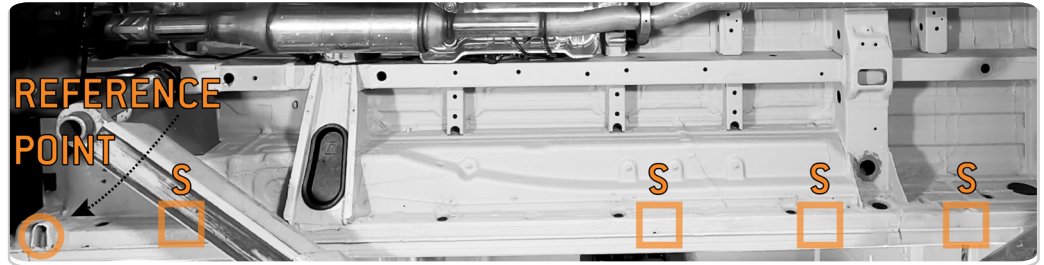

STEP | 04 INSTALLING BRACKETS

- 4.1** Seat the **Hangar Bracket** into place along the pinch seam and line up your mark with the center of the bracket.
- 4.2** Mark the center of each hole as pictured in the first illustration and drill out your pilot holes using a 3/16" Drill Bit. Be sure to drill from the outside of the van.
- 4.3** Replace the **Hangar Bracket** and drive four **1/4x0.75 Hex Head Drilling Screws** into the pilot holes using an Impact Driver and 7/16" Socket.

NOTE - The four mounting holes used in this step are slotted to allow for a small amount of lateral adjustment if necessary.

NOTE - There is a notch cut out into the upper portion of the bracket to aid in this alignment. It is recommended that you dry fit each bracket to make sure that they won't conflict with any existing units installed on your van (i.e. heaters, a/c units, water tanks).

NOTE - For more information about how to modify the hangar bracket layout to accommodate varying types of undercarriage configurations, please refer to our Help Center of the webpage.

- TOOLS REQUIRED FOR THIS STEP:**
- + DRILL
 - + 3/16" DRILL BIT
 - + IMPACT DRIVER
 - + 7/16" SOCKET
 - + RATCHET
 - + 9/16" SOCKET

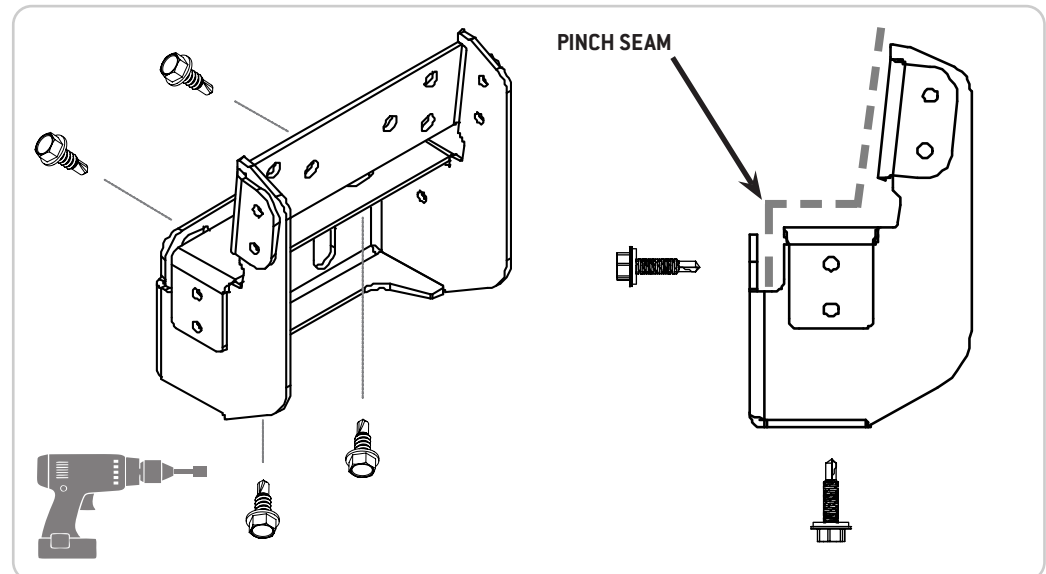
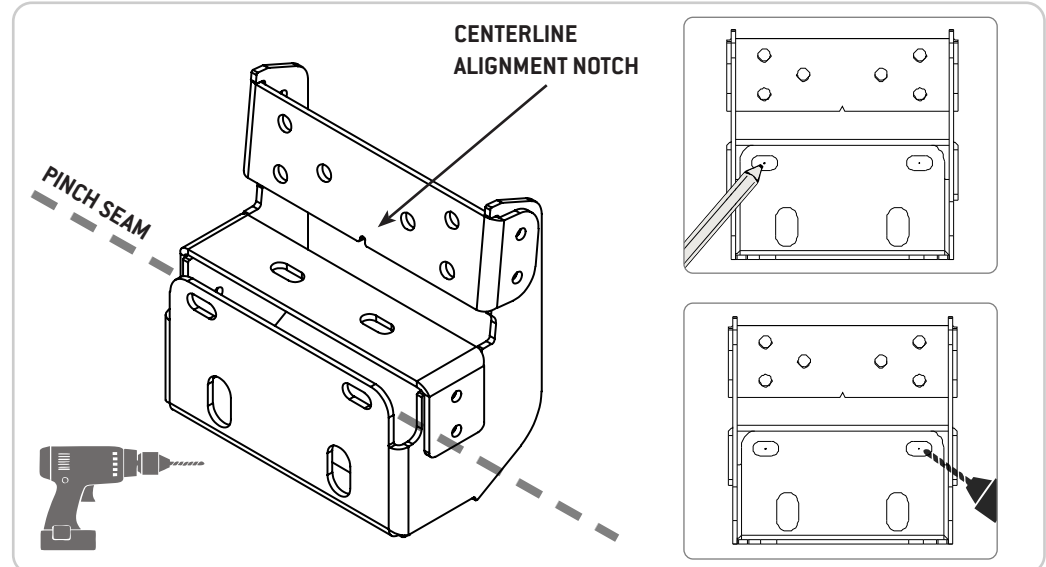

STEP | 06 PASSENGER BRACES

6.1 Start by installing **3/8 Rivet Nuts** into the passenger side of the van undercarriage using a **Rivet Nut Tool** with a **3/8-16 Mandrel**.

6.2 Once you've installed the Rivet Nuts, you can attach the **Passenger Side Braces**. There are two styles of Passenger Braces; **P1 & P2**. Refer to the first image on the right for locations. Fit the **P1 Side Brace** to the Rivet Nut and loosely thread a **3/8-16x1 Serrated Flanged Hex Head Screw**, again applying Loctite.

6.3 Sandwich a **Single Bracket Spacer Plate** between the brace and step assembly while threading another 3/8 Screw loosely into place.

6.4 Repeat the process for the **P2 Side Braces** and once complete, tighten down all the screws before moving on to the driver's side.

NOTE - We recommend using a *pneumatic or electric drill adapter rivet nut tool for this, although a manual rivet nut tool can work if you have enough ground clearance. We like the Astro Tools ADN38 XL model for a drill adapter. Pictured for reference.*

NOTE - The locations for these Rivet Nuts are circled in the first image to the right. It is always a good idea to double check your Rivet Nuts once installed to ensure they do not fall out or spin.

NOTE - Unlike the Passenger side, installing braces for the Driver's side will first require you to drill some holes before you can proceed to the application of Rivet Nuts.

TOOLS REQUIRED FOR THIS STEP:

- + RIVET NUT TOOL (WITH 3/8-16 MANDREL)
- + RATCHET
- + 9/16" SOCKET
- + LOCTITE

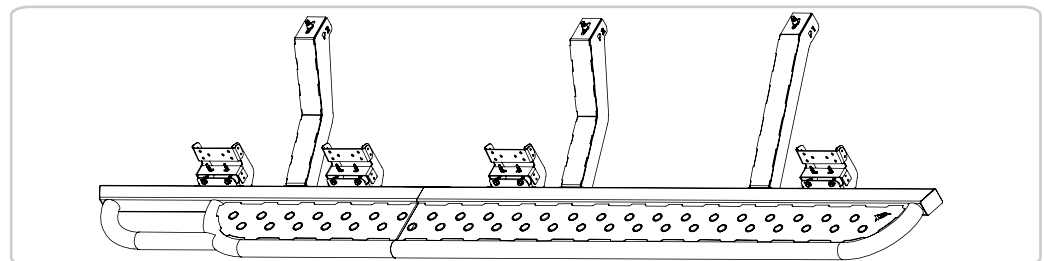
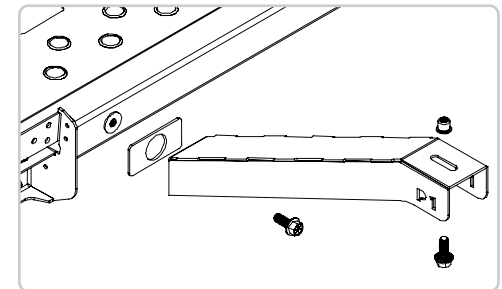
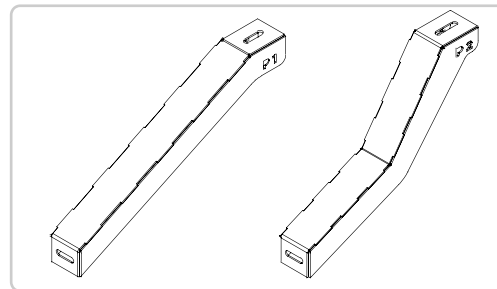
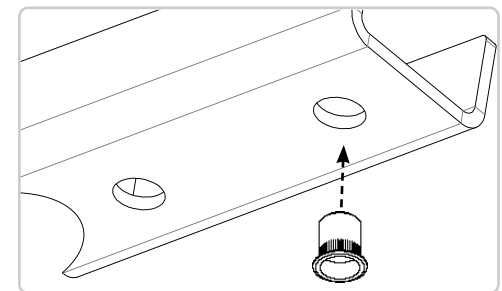
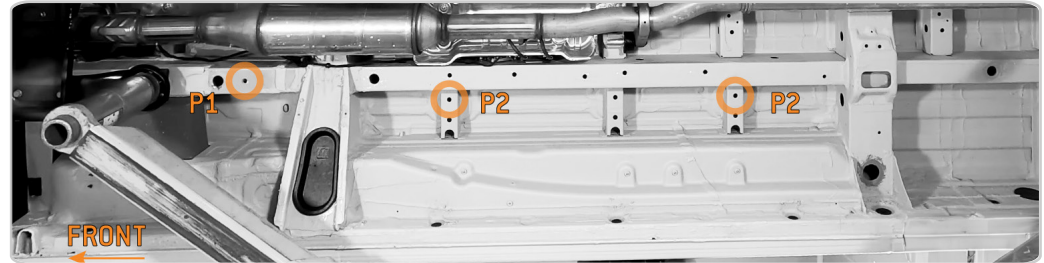

STEP | 07 DRIVER BRACES

There are two styles of **Driver Side Braces**; **D1 & D2**. Refer to first image on the right for locations.

7.1 To mark the locations for drilling, fit the **D1 Brace** to the side step assembly and thread in a **3/8-16x1 Serrated Flanged Hex Head Screw** firmly in place. Then, pressing the brace up against the van body, mark the center of the upper mounting slot to drill your hole. Repeat this process for both **D2 Braces**.

7.2 Once your spots are marked, remove the braces and drill a pilot hole using a 3/16" Bit. Continue by drilling out your rivet nut hole using a 17/32" Bit. Clean drill holes (rust preventative paint is recommended) and install your Rivet Nuts using a Rivet Nut Tool.

7.3 Once you've installed the Rivet Nuts, you can attach the driver side braces just like the passenger side, sandwiching the **Single Bracket Spacer Plate** between the brace and weldment assembly before tightening it together using Loctite and **3/8-16 Hex Head Screws**.

TOOLS REQUIRED FOR THIS STEP:

- + RIVET NUT TOOL
 - + IMPACT DRIVER
 - + 9/16" SOCKET
 - + DRILL
 - + 3/16" DRILL BIT
 - + 17/32" DRILL BIT
- + RATCHET
 - + LOCTITE

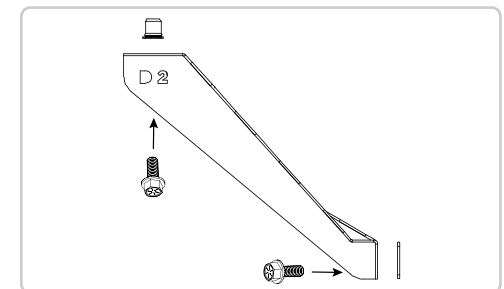
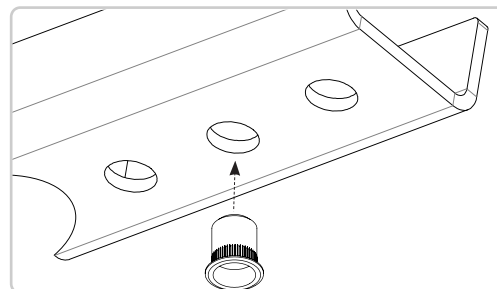
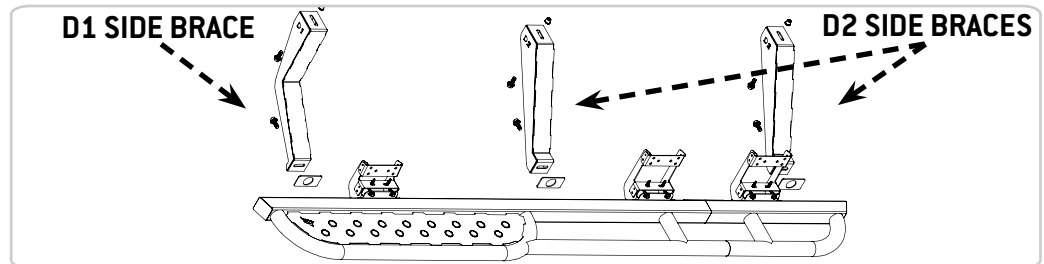
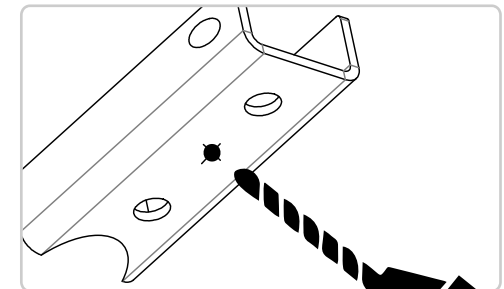
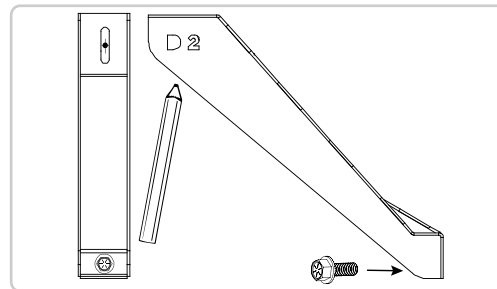
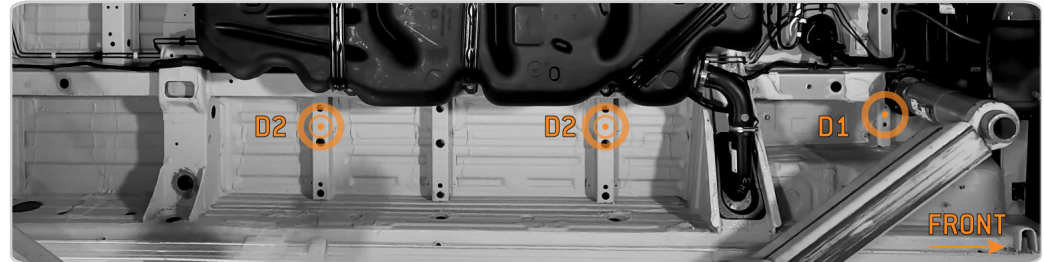

STEP | 08 FINISHING TOUCHES

8.1 Insert the remaining **1/4-20x0.75 Hex Head Drilling Screws** into the upper portion of the **Hangar Brackets** using a **7/16" Socket** and **Impact Driver**.

8.2 Insert two **1/4-20 Flanged Button Head Hex Drive Screws** into the connecting plate of the **Passenger Side Step** and fasten the two halves together with **1/4 Screw Flat Washers** and **1/4-20 Nylon Locknuts**.

8.3 Inspect to ensure all of your **3/8"** screws are tightened to **20ft-lbs**. Once you've ensured everything is tight the install is complete!

NOTE - *There are six holes to accommodate the uneven surface of the underside of the van. We recommend using at least two. Ensure you are screwing into a flat face for the most secure attachment.*

TOOLS REQUIRED FOR THIS STEP:

- + IMPACT DRIVER
- + 7/16" SOCKET
- + 5/32" ALLEN WRENCH

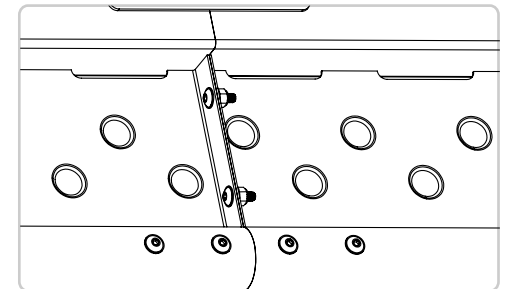
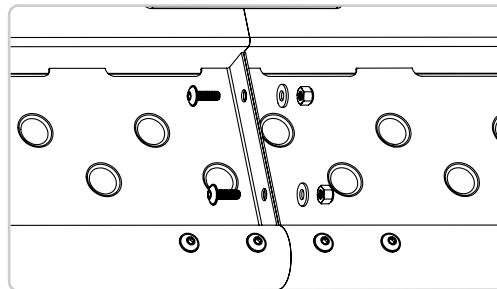
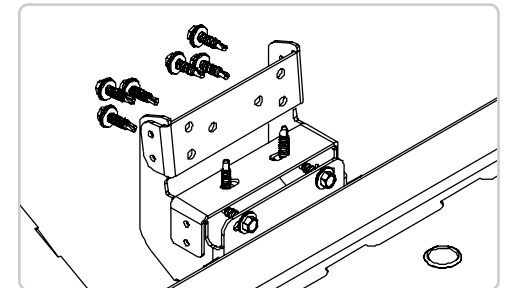
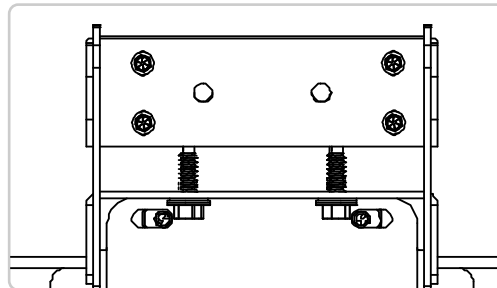
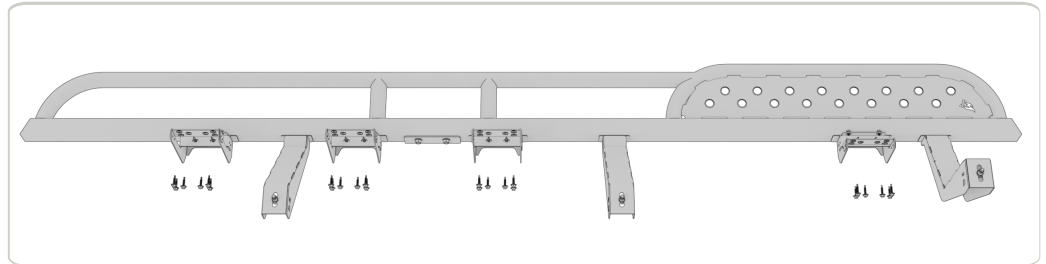
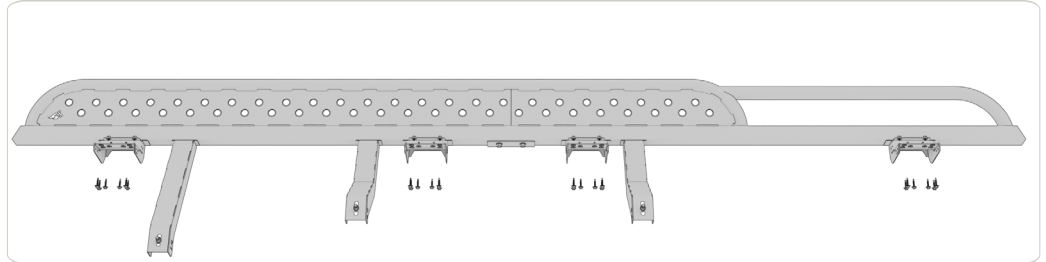

GET OUT AND EXPLORE!

+ LEAVE US A REVIEW

Happy with your new FVC product? We would love to hear (and see) from you! Head to the product page and click "Leave Review." Add a short review and upload a few photos to be showcased on the product page.

+ SHARE YOUR PICS

We love seeing how our customers use their FVC products and following along with your adventures. Tag us in your photos with: @flatlinevanco or send them to us via email. We love posting customer pictures in our feed!

+ NEED ANY HELP?

If you are having any issues with your product, please reach out, and we will make it right. FVC is a company of van and outdoor enthusiasts that design and use our own products, so we want you to be as stoked on your new parts as we are!

@FLATLINEVANCO