



INSTALLATION GUIDE

SPRINTER VAN BED SYSTEM - STANDARD BED: 3-PANELS

SP0301B



TOOLS REQUIRED (NOT INCLUDED)

- + POWER DRILL
- + 25/64" DRILL BIT
- + RIVET NUT TOOL
- + 7/32" ALLEN WRENCH
- + 5/8" SOCKET OR WRENCH (ADWAG INSTALL)
- + TAPE MEASURE
- + MARKER

INSTALL INFO

TIME TO INSTALL THIS PRODUCT: 2 HOURS

Additional help is suggested for a few of the install steps.

BEFORE YOU START

Please inspect the product and packaging upon delivery to ensure there are no issues and that all parts and hardware are accounted for.

Contact us ASAP if anything is missing at:
support@flatlinevanco.com

BEFORE YOU START

All Flatline Van Co products must be properly assembled and secured before attaching to your vehicle. Improper attachment could result in an automobile accident, and could cause serious bodily injury or death to you or to others involved. You are responsible for assembling and securing Flatline Van Co products to your vehicle, checking the mounting points and attachments prior to use, and regularly inspecting the products for wear and or damage. We always recommend you use a professional to install any aftermarket accessories to your vehicle. If you have no mechanical experience and are not thoroughly familiar with the installation procedures, you must have the product installed by a professional installer or other qualified persons. The responsibility is yours and must be taken seriously for everyone's safety.



PACKAGE CONTENTS

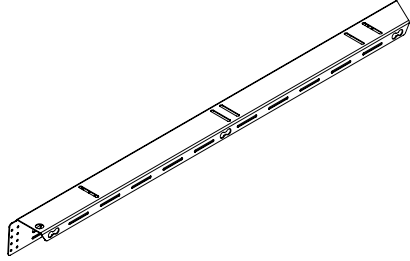

PASSENGER SIDE
BED RAIL

QTY: 1

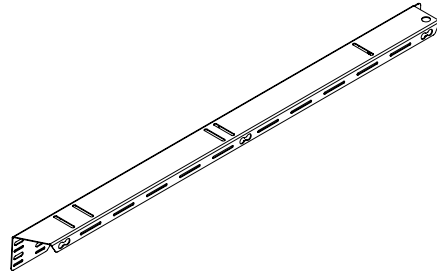

DRIVER SIDE BED RAIL

QTY: 1

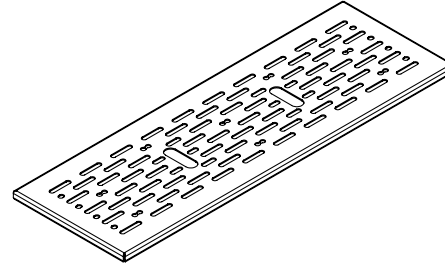

BED PANEL

QTY: 2

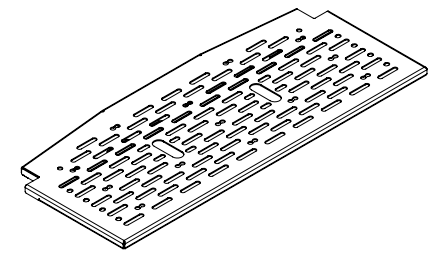

REAR BED PANEL

QTY: 1

HARDWARE

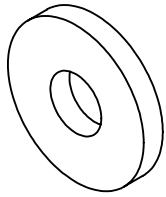

3/8 SCREW CUSHION WASHER

QTY: 6

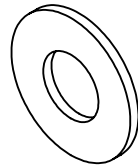

3/8 SCREW FLAT WASHER

QTY: 6

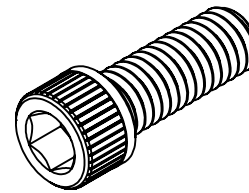

3/8-16 X 1 SOCKET HEAD
HEX DRIVE SCREW

QTY: 6

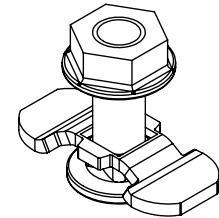

L-TRACK STUD

QTY: 8

INSTALL

STEP | 01 LAYOUT AND INSTALL PREP

The FVC Bed System is designed for install with the FVC Bed Bracket System, but is also DIY-mount and Adventure Wagon compatible.

ADWAG/PANEL KIT WITH L-TRACK INSTALL

1.1 L-Track Studs are included for installing bed rails to the L-Track of your Adwag or Wall Panel Kit.

[PAGE 6] [ADWAG \(OR PANEL KIT WITH L-TRACK\) INSTALL](#)

FVC BED BRACKET INSTALL

1.2 If you are installing an older version of the Bed System to our Bed Brackets, see the install bulletin [here](#).

[PAGE 7] [FVC BED BRACKET INSTALL](#)

DIY INSTALL

1.3 This install recommends using rivet nuts and screws. We like the Astro Tools ADN38 XL model for a drill adapter, but most rivet nut tools with a 1/4" Mandrel will work.

[PAGE 8] [DIY INSTALL](#)

TOOLS REQUIRED FOR THIS STEP:

L-TRACK INSTALL

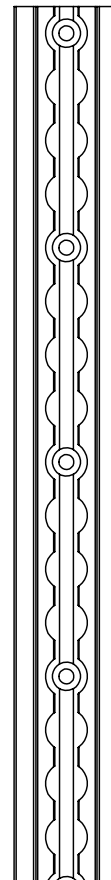
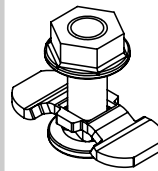

FVC BRACKET INSTALL

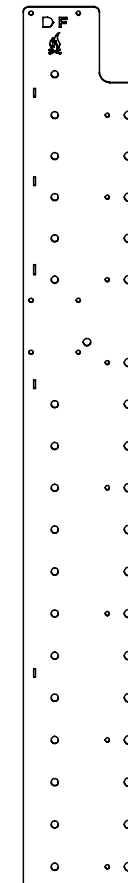
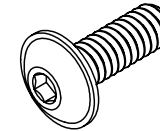

DIY INSTALL

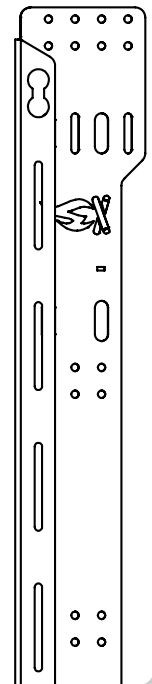
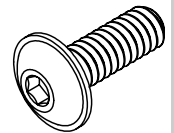
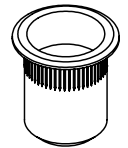

STEP | 02 RAIL-TO-VAN INSTALL

ADWAG/PANEL KIT WITH L-TRACK

2.1a See mounting slots highlighted in **FIG 1**. These are designed to accommodate L-Track Studs for use when attaching FVC Bed Rails to L-Track.

2.2a Raise bed rails up to L-Track, align mounting slots to desired location and insert L-Track Studs to corresponding L-Track Key Ways (**FIG 2**). Secure L-Track Stud with Wing.

2.3a Tuck the rear end of the rail behind the Adwag Rear Corner Trim if applicable and secure rail using L-Track Stud Nuts and a 5/8" Wrench (**FIG 3**).

[JUMP TO NEXT STEP](#)

TOOLS REQUIRED FOR THIS STEP: + 5/8" WRENCH

DRIVER SIDE RAIL

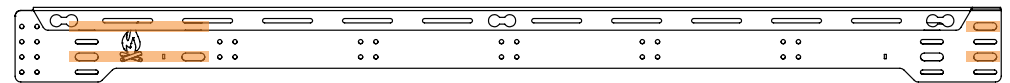

PASSENGER SIDE RAIL

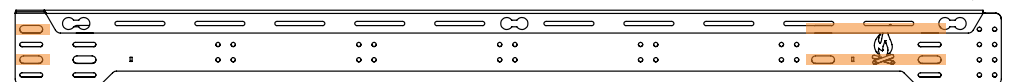

FIG 1

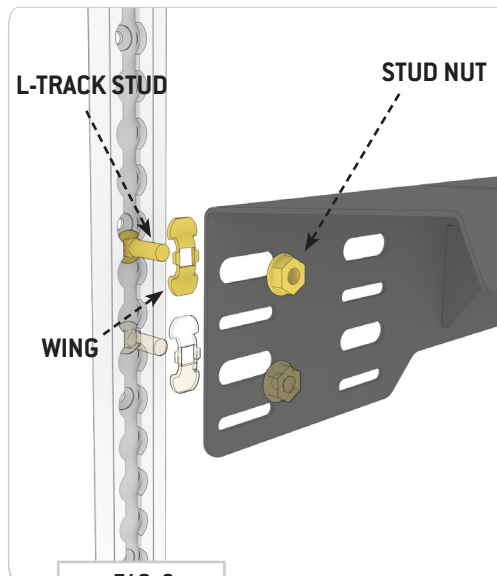

FIG 2

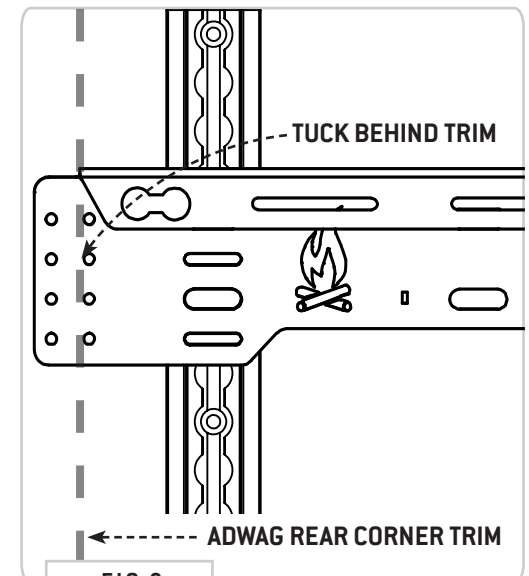

FIG 3

STEP | 02B RAIL-TO-VAN INSTALL

FVC BED BRACKETS

2.1b See mounting slots highlighted in **FIG 4**. These are designed to accommodate 1/4-20 screws for use when attaching FVC Bed Rails to your FVC Bed Bracket System.

2.2b Select desired height of bed.

NOTE - The width range for rail install is roughly **65.5" - 70.5"** measured wall-to-wall. This translates to a height range of roughly **18" - 47"** from the floor (**FIG 6**).

2.3b Raise bed rails up to Bed Brackets, align mounting slots to corresponding pem nut locations and secure bed rails to brackets using 1/4-20 screws (**FIG 5**).

[JUMP TO NEXT STEP](#)

TOOLS REQUIRED FOR THIS STEP: + TAPE MEASURE
+ 5/32" ALLEN WRENCH

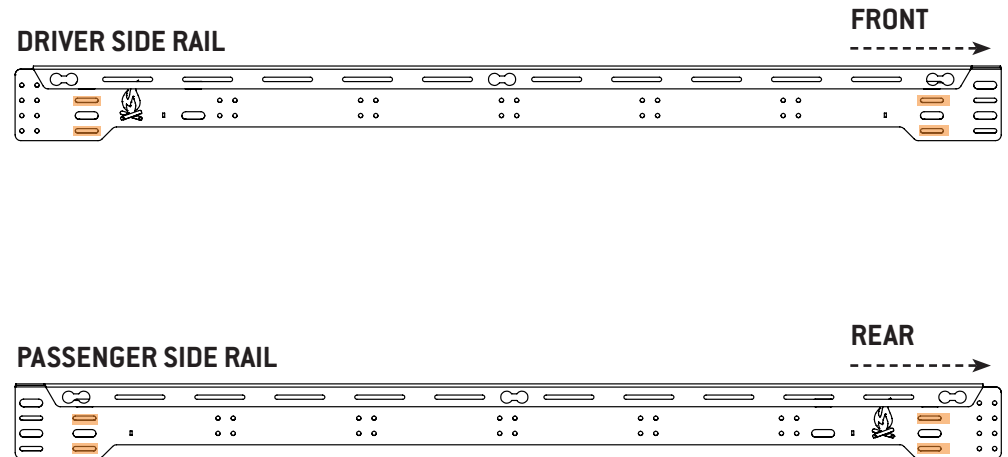

FIG 4

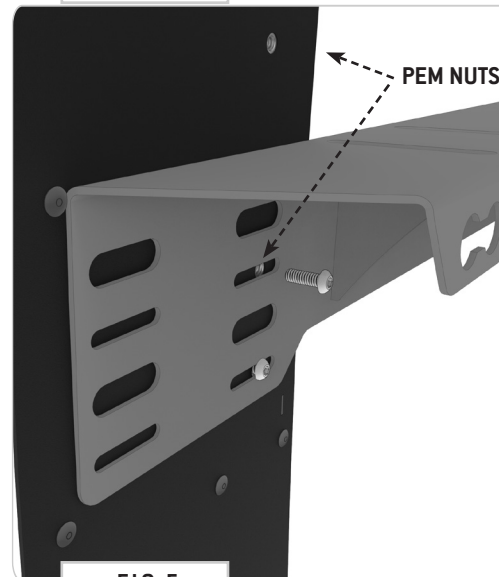

FIG 5

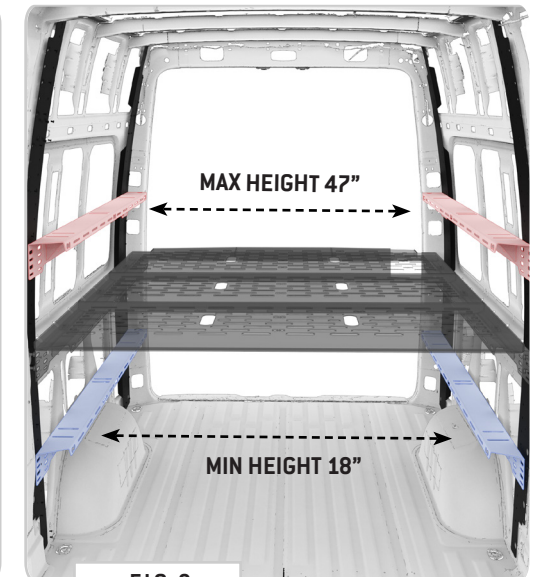

FIG 6

STEP | 02C RAIL-TO-VAN INSTALL

DIY INSTALL

2.1c See mounting slots highlighted in **FIG 7**. These are designed to accommodate 1/4" hardware for use when attaching FVC Bed Rails to the structural sheet metal of your van wall.

2.2c The structural member along the wall that provides the most surface area for securing the rails is highlighted in **FIG 8**.

NOTE - While mounting above or below this structural member, additional bracing could be used to provide additional support.

NOTE - The width range for rail install is roughly **65.5" - 70.5"** measured wall-to-wall. This translates to a height range of roughly **18" - 47"** from the floor (**FIG 9**).

2.3c Raise Bed Rail to desired height and mark out where to drill out holes for mounting. **It is recommended to use at least two rivet nuts and screws per end of each rail.**

2.4c Drill out holes using a **25/64" Drill Bit** and install **1/4" Rivet Nuts** into place.

2.5c Raise rails up to Rivet Nuts and secure with 1/4" Screws.

NOTE - Removing or drilling through existing wall panels may be necessary.

TOOLS REQUIRED FOR THIS STEP:

- + POWER DRILL
- + 25/64" DRILL BIT
- + RIVET NUT TOOL
- + TAPE MEASURE
- + MARKER
- + 5/32" ALLEN WRENCH

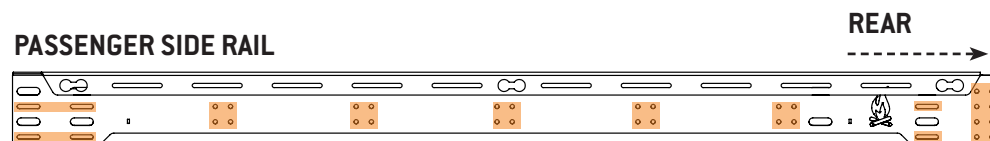
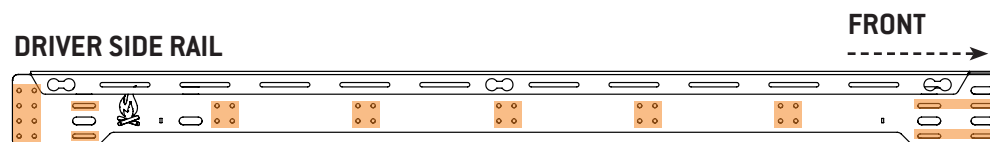
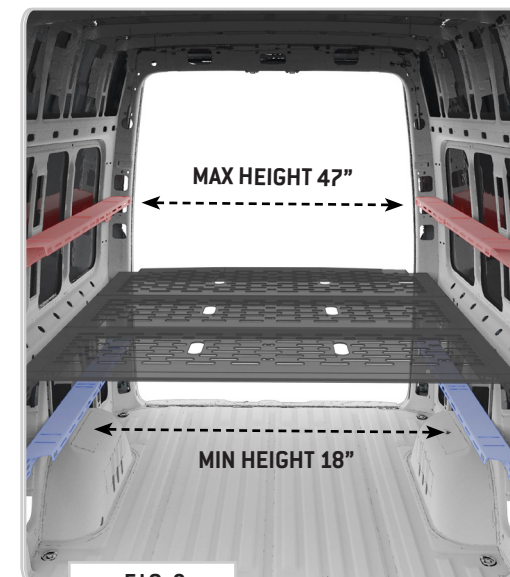
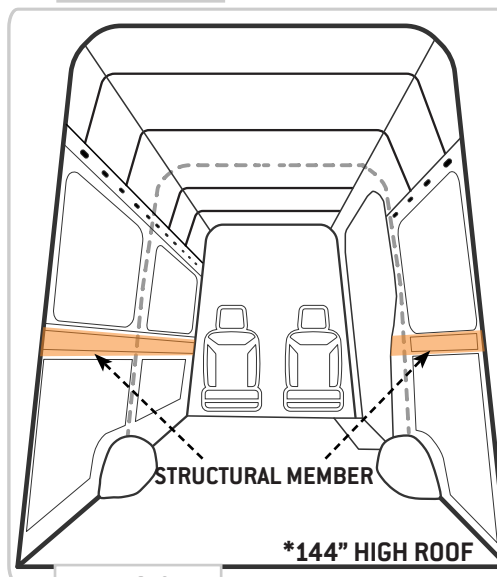

FIG 7



TOOLS REQUIRED FOR THIS STEP: + 7/32" ALLEN WRENCH

STEP | 03 PLACING BED PANELS

3.1 Once you have the bed rails up and fully mounted, you can simply place the bed panels on and fasten them to the rails using the **3/8-16" Socket Cap Screws, 3/8" Flat Washers and 3/8" Cushioning Washers (FIG 13)**.

NOTE - There are two series of mounting slots on the top side of the rails. You have the option for a **72" bed (FIG 10)** or a **75" bed (FIG 11)** for you taller folks! See **FIG 12** for slot locations.

NOTE - Periodically inspect the fasteners to ensure they remain tight. The rubber washer is present to reduce vibration-related road noise, but it is not uncommon for the fasteners to loosen up over time.

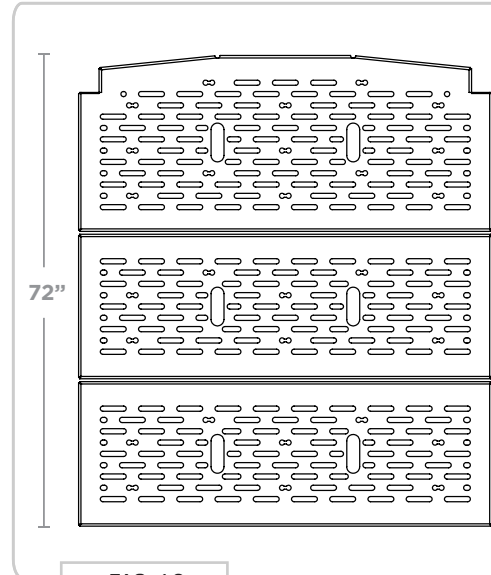

FIG 10

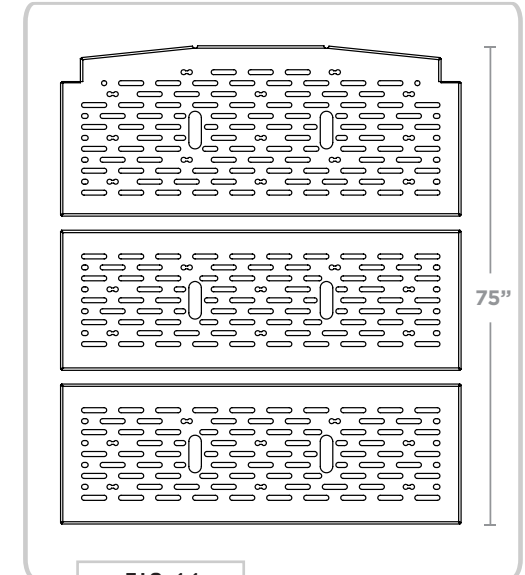

FIG 11

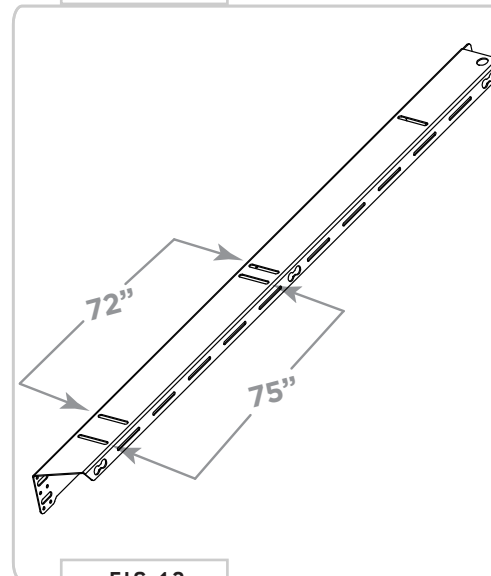

FIG 12

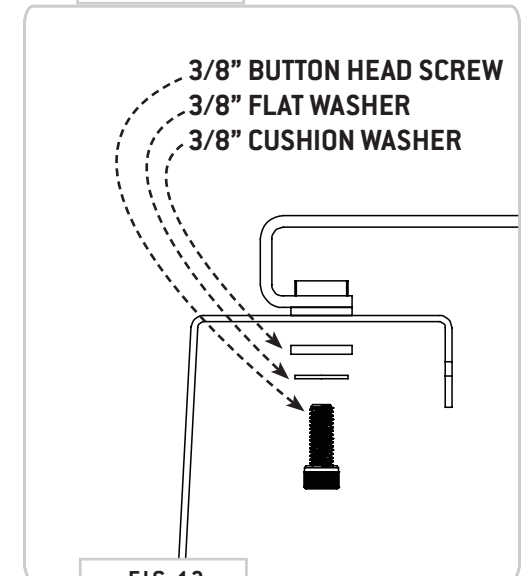

FIG 13

GET OUT AND EXPLORE!

+ LEAVE US A REVIEW

Happy with your new FVC product? We would love to hear (and see) from you! Head to the product page and click "Leave Review." Add a short review and upload a few photos to be showcased on the product page.

+ SHARE YOUR PICS

We love seeing how our customers use their FVC products and following along with your adventures. Tag us in your photos with: @flatlinevanco or send them to us via email. We love posting customer pictures in our feed!

+ NEED ANY HELP?

If you are having any issues with your product, please reach out, and we will make it right. FVC is a company of van and outdoor enthusiasts that design and use our own products, so we want you to be as stoked on your new parts as we are!



@FLATLINEVANCO